



ITEX Dynamic Headspace Powerful Sample Enrichment for GC



ITEX (In-tube extraction) Dynamic Headspace Tool

Purge & Trap (P&T) sensitivity without the pitfalls of P&T Systems

- Rapid and efficient enrichment of volatile and semi-volatile compounds from solid, liquid and gaseous samples
- In-tube extraction and thermal desorption using industry standard adsorbents
- Syringe-only concept: no sample loops, transfer lines, or switching valves that could be contaminated
- Active cooling allows for rapid sample preparation and short cycle times
- No modifications of the GC injector needed
- PAL Robotic Tool Change enables head space, SPME and ITEX-sampling within the same sequence on one system

ITEX Dynamic Headspace
high sensitivity, no hassle

Typical application areas include:
(see pages 6-9 for more details):

- Drinking and waste water
- Food, additives, flavors
- Chemical
- Clinical

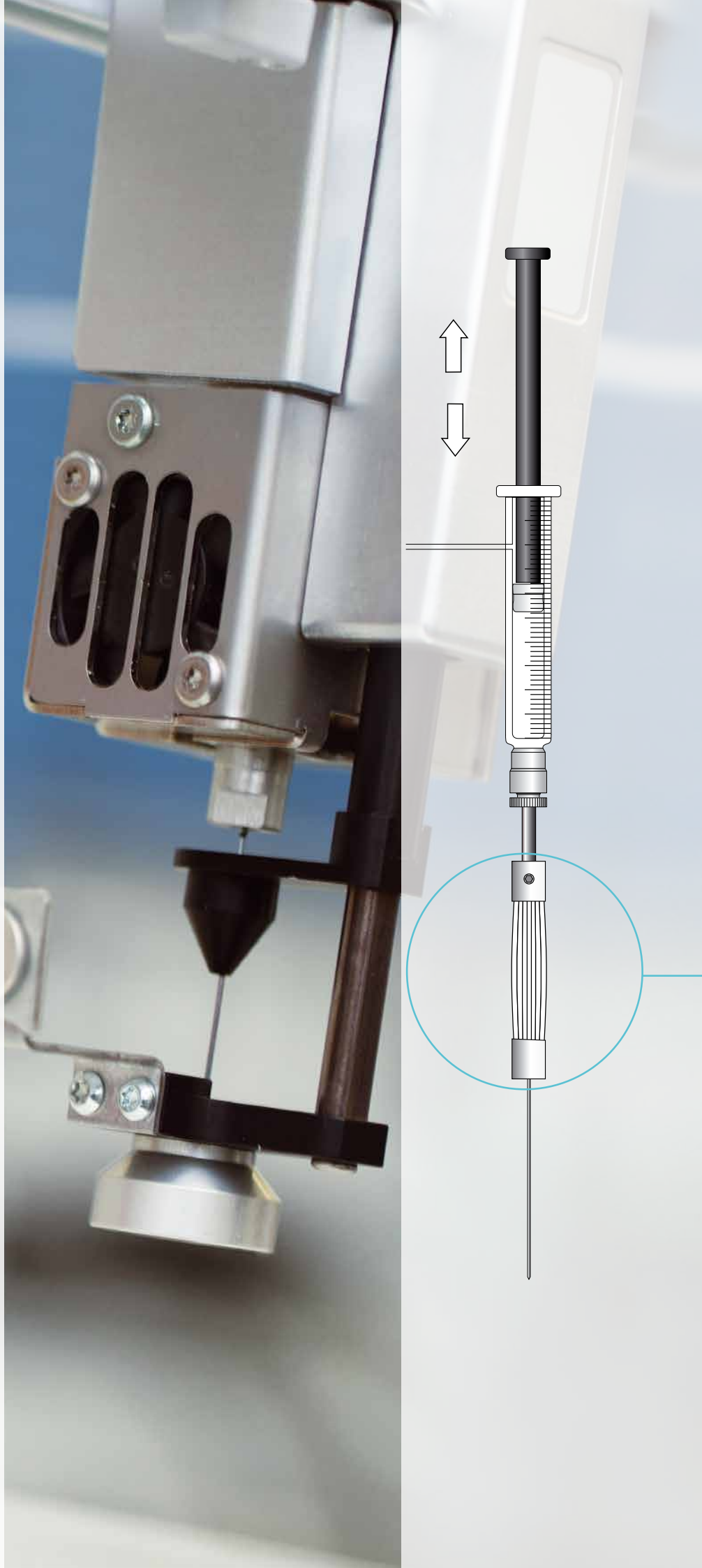

ITEX Dynamic Headspace Extraction Procedure

The sample is heated and / or agitated in a sealed vial.

The ITEX needle pierces the sealed vial and the heated syringe pumps the the headspace gas through the cold trap.

An additional step to remove water from the trap can be added.

The loaded ITEX trap is flash heated up to 350°C and analytes are desorbed into the hot GC injector.

After thermal desorption the hot ITEX trap is cleaned with inert flush gas.

Active cooling allows for short cycle times.

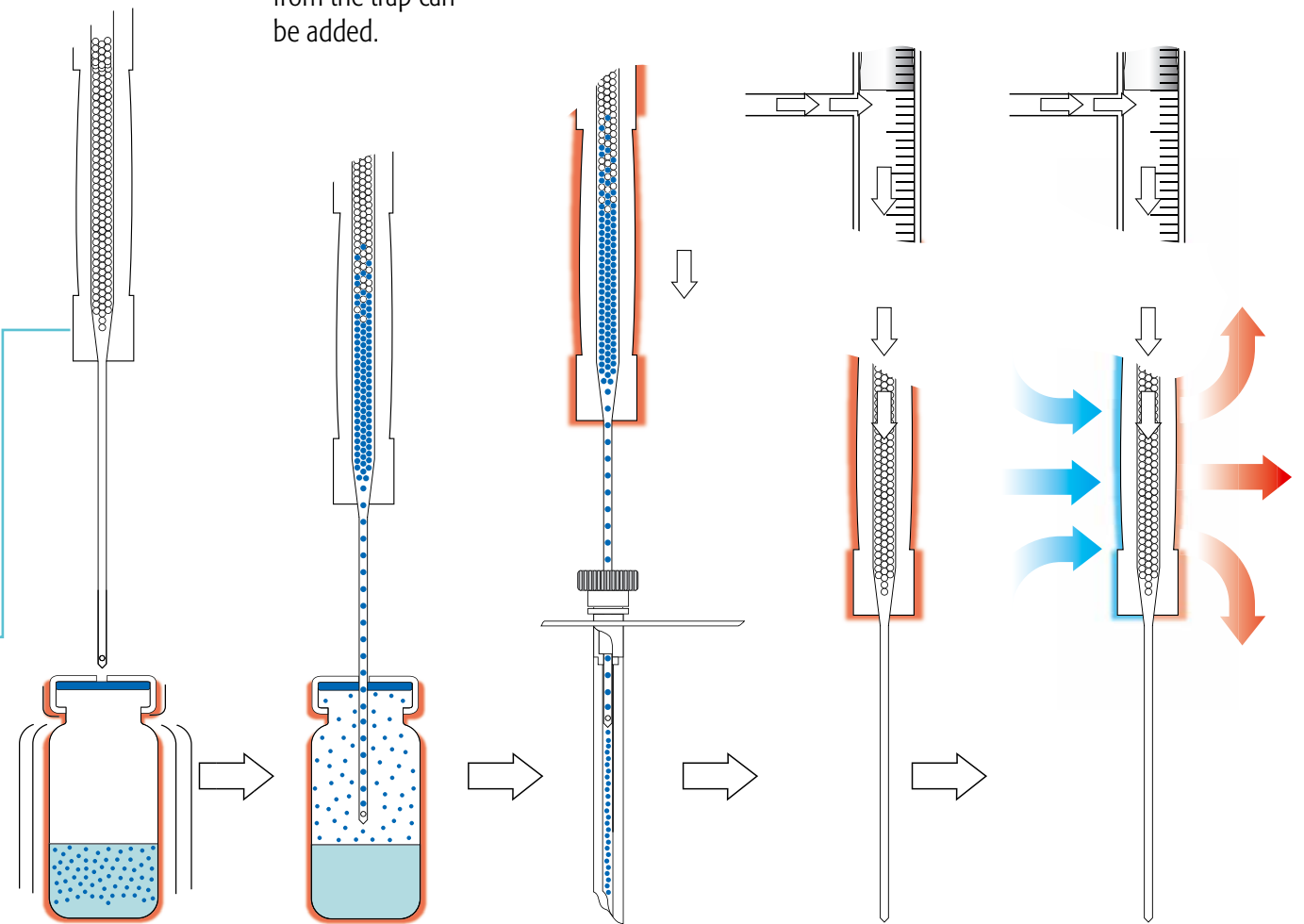

Sample conditioning

Adsorption

Desorption

Trap cleaning

Active cooling

Powerful options for
ITEX Dynamic Headspace

The PAL RTC
(Robotic Tool Change)
takes productivity to
new levels



Robotic Tool Change and ITEX Dynamic Headspace, ingeniously productive.

- Headspace, SPME and ITEX sampling within the same sequence
- Automatic selection of the syringe with optimal accuracy, e.g. for adding standards or preparing serial dilutions
- Automated optimization of methods e.g. by selecting the most suitable ITEX trap and conditions
- Derivatization reactions performed without manual intervention for productivity, process safety and protection against hazardous chemicals
- Possibility to permanently configure several workflows on one system for a walk-up prep station, e.g. Liquid/Liquid Extraction and Solid Phase Extraction (SPE)

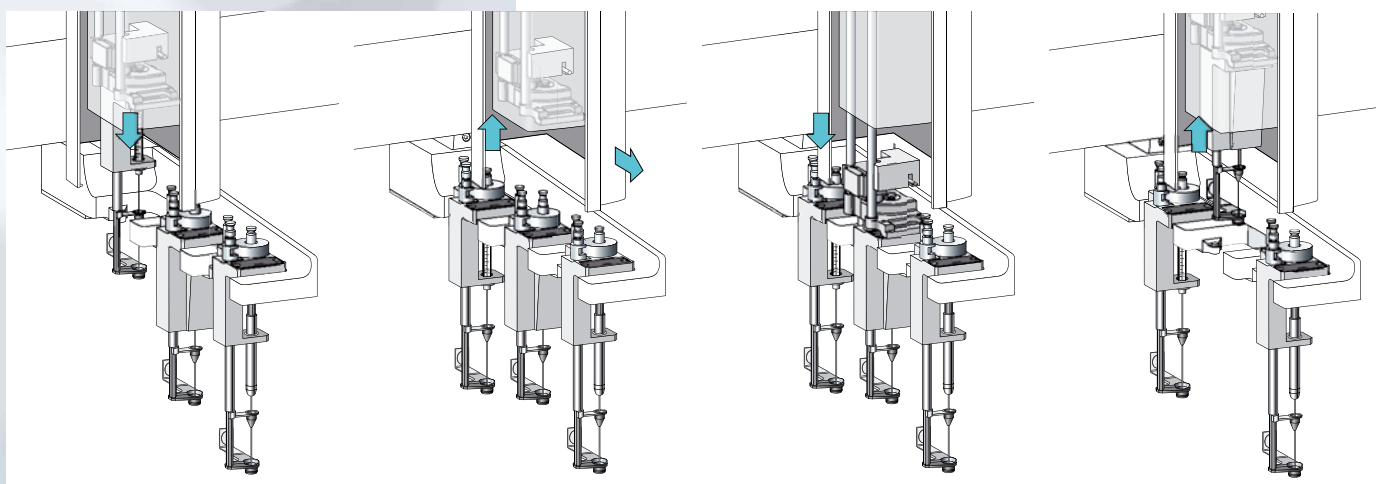

For more information about
Robotic Tool Change

Environmental application

VOCs, BTEX in water at ppt levels, EPA 502.2

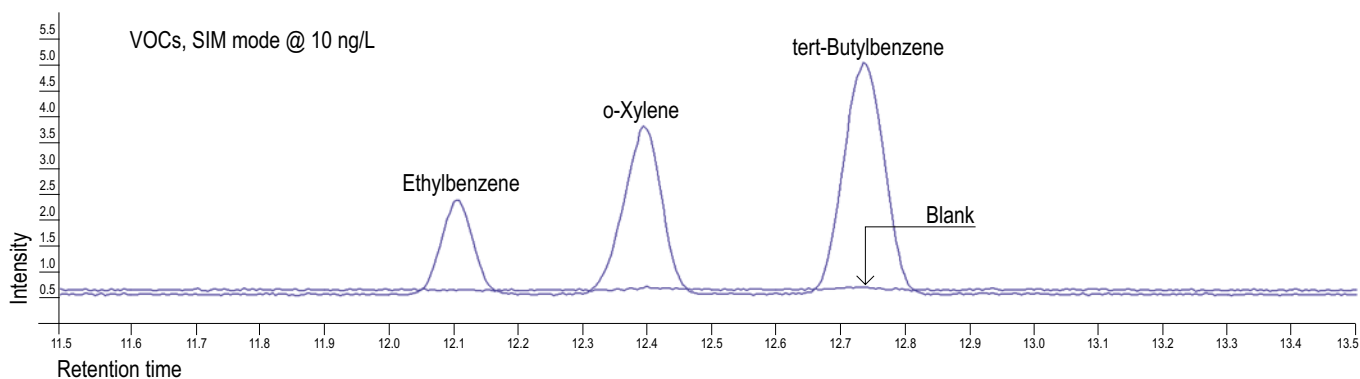
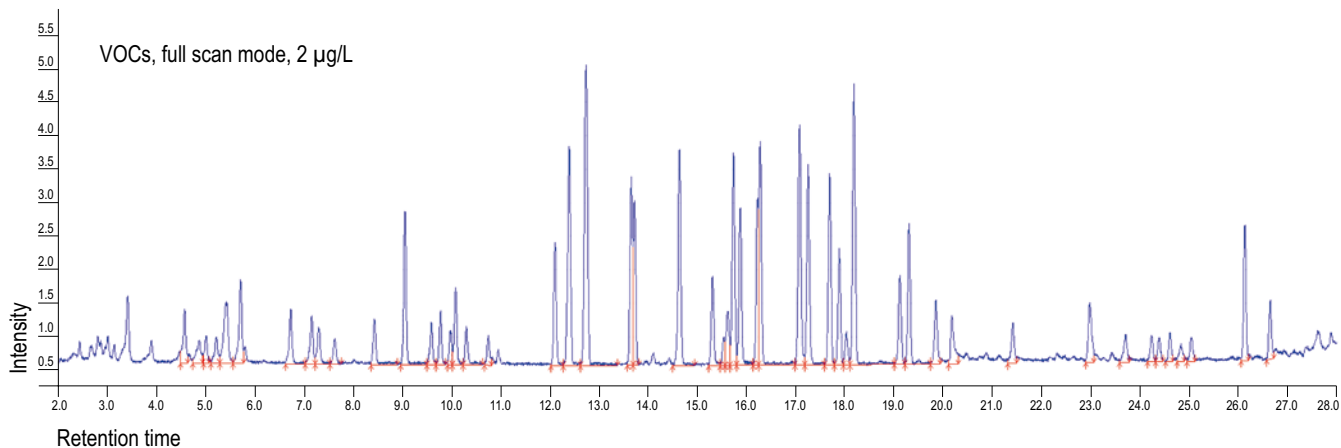

Sample preparation:

Full scan data: 2 µg/L MegaMix® Standard, 524.2 73 components), Restek PN 30601

SIM scan data: 10 ng/L MegaMix® Standard, 502.2 (54 components), Restek PN 30432

10mL water + standard, filled into 20 mL headspace vial, + 3g NaCl

Chromatography (Shimadzu GC-2010 Plus):

Column:	Rxi® 624 Sil MS, 30 m x 0.32 mm, 1.8 µm df
Carrier gas:	helium, 93.2 kPa
Temperature program:	40°C for 1 min, 5°/ min to 250°C, 2 min hold
Injector:	split/split less @ 225°C
Liner	Restek catalog # 23321.1, 3.5 mm Splitless Single Tpr Gsnk
GC:	Shimadzu GC-2010 Plus
Detector:	Shimadzu GCMS-Q2010 SE

ITEX Dynamic Headspace conditions

Incubation temp.	40°C
Incubation time	3 min
Syringe temp.	50°C
Extraction strokes	30 x 1 mL @ 40°C (12 min)
Extraction speed	100 µL/s
Desorption	200°C with 1 mL headspace,
ITEX trap material:	Tenax TA

Food application

Comparison of flavors/softeners

ITEX Dynamic Headspace vs. Poropak Filter

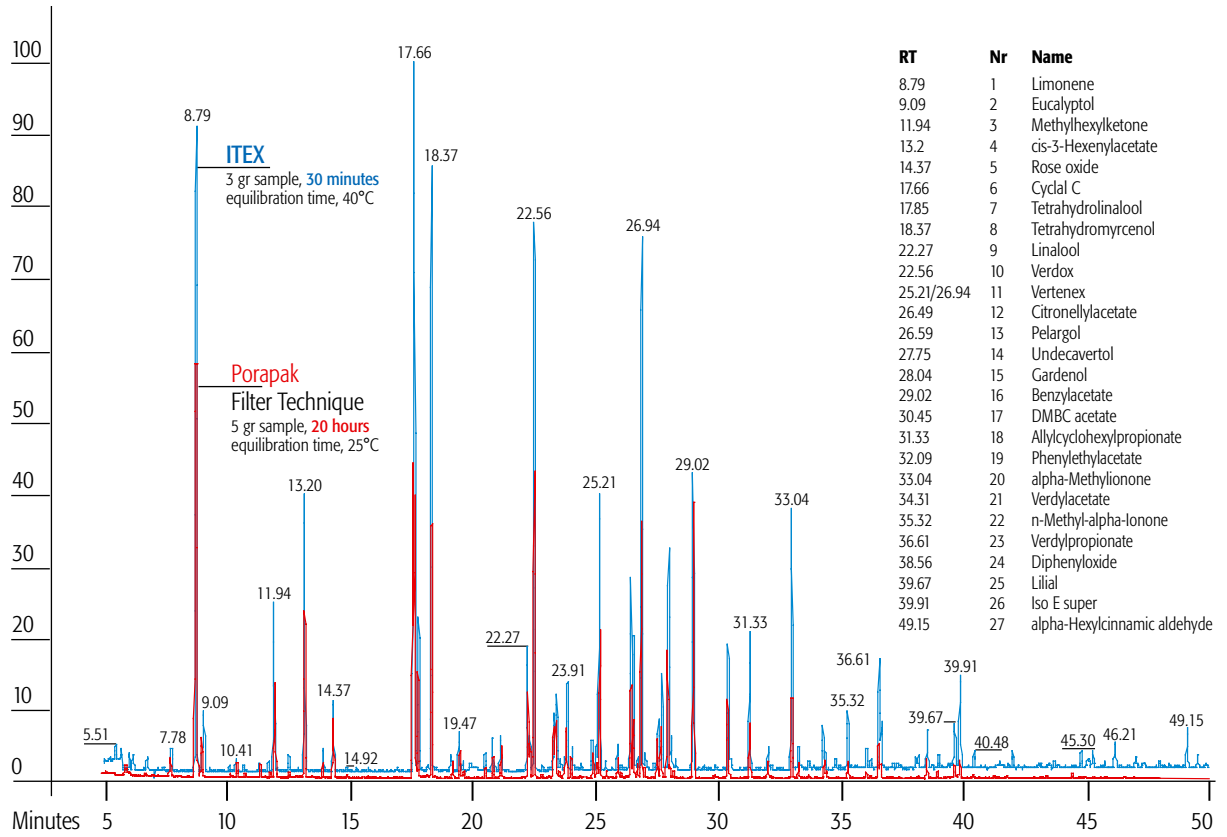

Chromatography (Thermo TraceGC):

Column:	Stabilwax 30 m x 0.25 mmID x 0.25 mm film thickness
Oven:	35°C - 0.5 min. 15°C / min. 50°C - 0min. 5°C / min. 220°C / 1min.
SSL:	splitless with surge, surge pressure 20kPa/0.4 min. (0.5ml), split flow 100 mL /0.3 min.
Carrier:	He, 1 mL/min constant flow with vacuum compensation

MS conditions (Thermo Trace MS system):

Ionisation mode:	El+
Source temperature:	230°C
Interface:	220°C
Mass:	20-350 amu

ITEX Dynamic Headspace conditions:

Incubation temp:	40°C
Incubation time:	30 min.
Syringe temp:	45°C
Extraction volume:	1000 µL/stroke
Extraction strokes:	10
Extraction speed:	100 µL/sec.
Desorption temp:	200°C
Desorption speed:	100 µL/sec.
Flush time:	5 min.

Courtesy of: Givaudan Research Company,
CH-8600 Dübendorf, Zürich. Switzerland, H. Koch

Environmental application

Purgable organic compounds (VOCs) in water by GC/MS, EPA 524.2

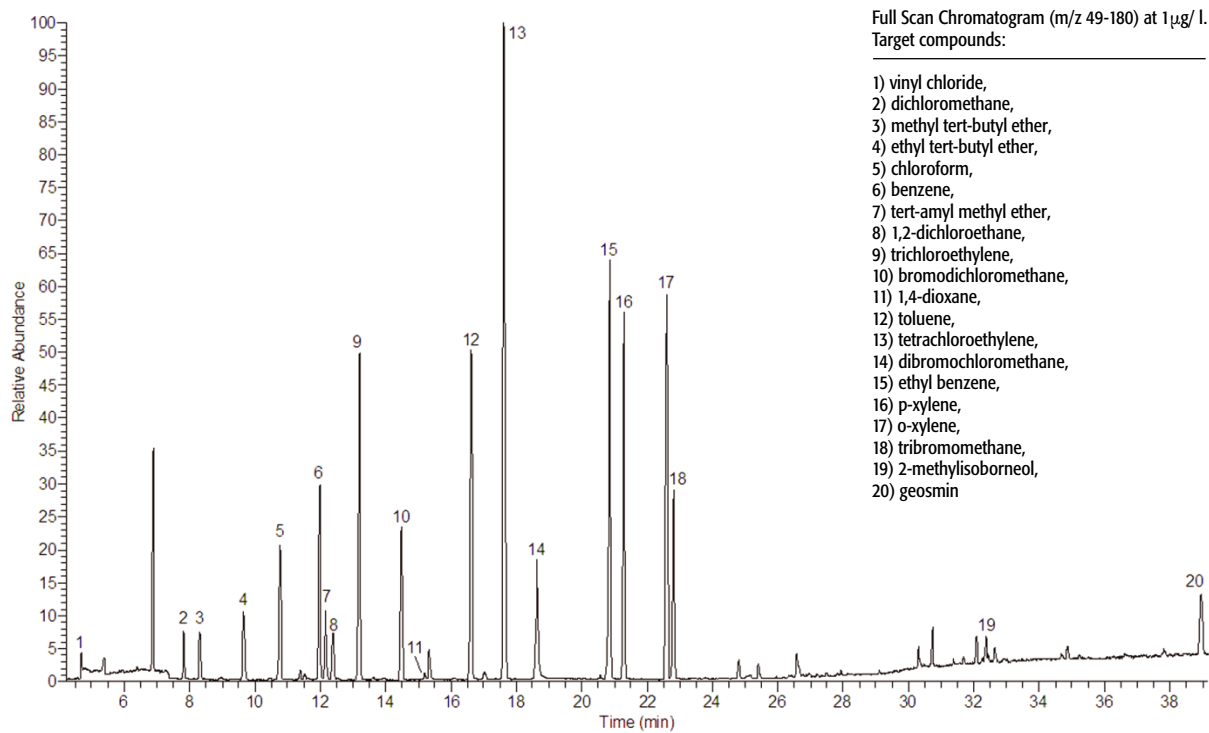

ITEX ppt sensitivity for volatile or semi-volatile compounds

Instrumentation

Conditions

GC	Thermo Trace GC Ultra	40°C for 1 min., 4°C/ min. to 130°C, 10°C/ min. to 200°C for 10 min.
MS	Thermo DSQII	El 70ev, Scan mode m/z 49-180
Injector	AtasGL Optic 3 with cryfocusing unit	280°C Cryotrap – 165°C for 30 sec., 30°C/ sec. to 250°C
GC Column	Restek VMS 60 m x ,0.32 mm i.d., 1.8 µm film	1.5 mL/ min. constant flow
Autosampler	PAL RTC with ITEX Dynamic Headspace, Tenax GR/Carbosieve S3 trap	10 ml sample in 20 ml headspace vial

ITEX Dynamic Headspace, extraction parameters

Sample storage in tray cooler:	25°C	Extraction volume:	1000 µL
Tray temp:	40°C	Extraction flow rate:	100 µL/sec.
Syringe temp:	60°C	Desorption volume:	500 µL
Incubation time:	5 min.	Desorption flow rate:	10 µL/sec.
Agitator speed:	500 rpm	Desorption temp:	300°C
Extraction temp:	60°C	Trap cleaning temp:	350°C
Extraction stroke:	60	Trap cleaning time:	5 min.

Sensitivity comparison between ITEX Dynamic Headspace and Purge & Trap

Sensitivity Comparison of ITEX with Purge & Trap

Compound	ITEX Dynamic Headspace					Purge & Trap	
	MDL [$\mu\text{g L}^{-1}$]	Linear range [$\mu\text{g L}^{-1}$]	R ²	RSD [%]	Recovery [%]	MDL [$\mu\text{g L}^{-1}$]	RSD [%]
Vinylchloride	0.008	0.02-2.0	0.999	5.3 (n=63)	103	0.008	
Dichloromethane	0.01	0.03-2.7	0.999	5.5 (n=63)	97		
MTBE	0.004	0.01-1.5	0.999	6.1 (n=63)	88	0.001	4.7
ETBE	0.001	0.004-1.5	0.998	6.6 (n=77)	94	0.009	5.1
Chloroform	0.004	0.007-2.9	0.999	5.4 (n=77)	99	0.008	
Benzene	0.001	0.002-1.8	0.999	5.4 (n=84)	89	0.002	5
TAME	0.001	0.004-1.5	0.999	5.8 (n=77)	95	0.01	3
1,2-dichloroethane	0.002	0.006-2.5	0.999	5.3 (n=77)	97		
Trichloroethylene	0.001	0.007-2.9	0.999	5.2 (n=77)	95	0.003	5.3
Bromodichloromethane	0.001	0.002-4.0	0.999	6.1 (n=91)	97	0.007	5.2
1,4-Dioxane	0.07	0.1-2.1	0.998	8.9 (n=49)	59		
Toluene	0.005	0.009-1.7	0.998	7.3 (n=70)	96	0.001	4.5
Tetrachloroethylene	0.001	0.003-3.2	0.999	5.7 (n=84)	97	0.004	7.3
Dibromochloromethane	0.005	0.02-4.9	0.999	5.8 (n=70)	98	0.001	4.1
Ethylbenzene	0.002	0.009-1.7	0.999	8.7 (n=70)	93	0.001	5.5
p-Xylene	0.004	0.009-1.7	0.999	8.9 (n=70)	117	0.001	4.9
o-Xylene	0.005	0.02-1.7	0.999	6.9 (n=63)	90	0.002	4.7
Bromoform	0.002	0.006-5.8	0.999	5.7 (n=84)	94		
2-Methylisoborneol	0.03	0.1-2.0	0.999	5.5 (n=49)	94	0.001	5.6
Geosmin	0.06	0.1-2.0	0.999	5.1 (n=49)	88	0.002	6.1

MDL: Method detection limit

Ref: Laaks J, Jochmann MA, Schilling B, Schmidt TC ; Anal. Chem. 2010, 82, 7641-7648

Further application examples

Environmental

In-Tube Extraction of Volatile Organic Compounds from Aqueous Samples: An Economical Alternative to Purge and Trap Enrichment

Jens Laaks,† Maik A. Jochmann,* †
Beat Schilling, and Torsten C. Schmidt†
Anal. Chem. 2010, 82, 7641–7648

Clinical

Headspace In-Tube Extraction Gas Chromatography–Mass Spectrometry for the Analysis of Hydroxylic Methyl-Derivatized and Volatile Organic Compounds in Blood and Urine

Ilpo Rasanen, Jenni Viinamäki, Erkki Vuori, and Ilkka Ojanperä*
J Analytical Toxicology, 34, 2010, 113-121

Food

In-tube Extraction and GC–MS Analysis of Volatile Components from Wild and Cultivated sea buckthorn (*Hippophae rhamnoides* L. ssp. *Carpatica*) Berry Varieties and Juice

Sonia A. Socaci,^a Carmen Socaciu,^{a*} Maria Tofan,^a Ioan V. Ratib and Adela Pintea - Phytochem. Anal. 2013, 24, 319–328

Automated and quantitative headspace in-tube extraction for the accurate determination of highly volatile compounds from wines and beers
Julián Zapata, Laura Mateo-Vivaracho, Ricardo Lopez, Vicente Ferreira*
J. Chromatography A, 1230 (2012) 1– 7

Chemical

Microwave-assisted nonionic surfactant extraction of aliphatic hydrocarbons from petroleum source rock

A. Akinlua^{a,*}, M.A. Jochmann^b, J. Laaks^b, A. Ewert^b, T.C. Schmidt^b - Analytica Chimica Acta 691 (2011) 48–55

PAL System Tools
and Modules
complementing
ITEX Dynamic Headspace



ITEX Dynamic Headspace Specifications

	Trap temperature range	40°C - 350°C
	Syringe temperature range	40°C - 150°C
	Extraction flow rates	10 $\mu\text{L/s}$ - 1000 $\mu\text{L/s}$
	Extraction stroke cycles (strokes/sample)	0 - 1000
	Extraction volume	0 μL - 1300 μL
	Incubation time	up to 600 min
	Standard adsorption material	Tenax TA 80/100 mesh, other materials upon request
New	Water removal step with adjustable trap temperatures	40°C - 150°C
New	Ventilated trap for quick sample processing	Fast cooling of trap < 2 minutes

PAL System Modules and Tools



Agitator Module

- Incubation and agitation of 6 samples
- Incubation temperatures 40-200°C
- Agitation speed 250-750 rpm
- For 2 mL, 10 mL, 20 mL vials



Vortex Mixer Module

- Efficient mixing for reagent or standard addition
- Liquid/liquid extraction, dissolution of solids
- For 2 mL, 10 mL, 20 mL vials



Headspace Tool

- Consistent headspace sampling
- 1000, 2500 and 5000 μL syringes available
- Syringe flush with inert gas
- Magnetic vial transport for 2 mL, 10 mL, 20 mL vials

SPME Tool

- The tool for fully automatic SPME sampling
- New holder for increased fiber protection
- Compatible with a variety of SPME fibers
- Optional Fiber Conditioning Module



Distributed by:

BGB GC|LC
MS|CE

www.bgb-shop.com

Switzerland BGB Analytik AG • Rohrmattstrasse 4 • 4461 Böckten • Phone +41 61 991 00 46 • Fax +41 61 991 00 25 • sales@bgb-analytik.com

Benelux BGB Analytik Benelux B.V. • Drielandendreef 42 • 3845 CA Harderwijk • Phone +31 341 700270 • Fax +31 341 700271 • sales.benelux@bgb-analytik.com

France BGB Analytik France S.A.S. • 81 Vie de l'Etraz • 01630 St. Jean de Gonville • Phone +33 450 488567 • Fax +33 450 562378 • sales.fr@bgb-analytik.com

Germany BGB Analytik Vertrieb GmbH • Mühlestraße 1 • 79539 Lörrach • Phone +49 7621 5884270 • Fax +49 7621 5884289 • sales.de@bgb-analytik.com

For more information on the new generation PAL Systems visit:

www.palsystem.com



PAL is a registered trademark of CTC Analytics AG, Switzerland