



2017/2018 Product Catalog

**crs** | Chromatography  
Research Supplies



Since 1991, Chromatography Research Supplies, Inc. (CRS) has become known worldwide as a leading manufacturer and innovator in high-quality specialty supplies, primarily in the GC market. We are grateful for the opportunity to serve our customers, and we look forward to working with you for another 25 years.

At CRS we manufacture and sell products under our own brand name, as well as distributing other well-known brands in the industry. A substantial part of CRS sales are exported, and the company ships to markets all around the world. We specialize in manufacturing electronic and manual crimping tools, gas filters, ferrules, and injection port septa. We also offer a wide range of vials, caps, seals, and other GC accessories. Our GC consumables are used in analytical laboratories worldwide in various industries including food safety, flavor, fragrance, environmental, pharmaceutical, petrochemical, and forensic sciences.

Along with our popular lines of standard products, we can also custom-design and build products for your special applications and requirements. For whatever your analysis demands, our experienced team of chemists and engineers can help meet your specific needs and provide a solution that is right for you.

Our number one job is to provide excellent and useful products and to provide the service you expect. Thank you for trusting us as your partner.

The CRS Team



## Table of Contents



Gas Purifiers & Filters/Traps . . . . . 3



Ferrules . . . . . 29



GC Septa . . . . . 41



Crimping Tools . . . . . 49



Vials, Caps, and Seals . . . . . 55



Accessories . . . . . 89



Products By GC Manufacturer . . . . . 97

Index . . . . . 108



**In the lab, we're your  
trusted source for  
routine analysis.**

**You can rely on CRS  
products for consistent  
results.**

**crs** | Chromatography  
Research Supplies





## Gas Purifiers & Filters

Advanced Filter System Purifiers . . . . .	4-5
Reconditioning Program . . . . .	6
ZPure™ High-Purity Inline Gas Filters . . . . .	7-18
Stainless Steel . . . . .	7-13
ZPure™ M Refillable . . . . .	14
Glass Indicating . . . . .	15-18
SPure™ General-Purpose Inline Gas Filters . . . . .	19-22
Quick Connect Replacements . . . . .	23-24
Legacy Purifiers . . . . .	25-26
Model 1000 Oxygen . . . . .	25
Model 500 Moisture . . . . .	25
Model 300 Hydrocarbon . . . . .	26
Carbon Dioxide . . . . .	26

## AFS Purifiers I, II & III

- High purity, clean flow path: Gas contacts only metal, glass and fluoroelastomer seals
- High capacity and efficiency in a single cartridge
- Easy cartridge replacement with twist on/off assembly knob
- Double seal construction for safety (especially when using hydrogen gas)
- Check valves protect gas lines during cartridge replacement
- Includes mounting hardware for wall or bench
- Stainless steel fittings
- Reconditioning program allows for recycling of cartridge

### Innovative Design

Two part system includes a small stainless steel manifold and a high capacity purifier cartridge.

The manifold mounts to a laboratory wall or bench with brackets included in the installation kit, and connects to the gas lines with stainless steel compression fittings.

The cartridge easily attaches and detaches from the manifold with an assembly knob. To change the cartridge, simply twist the knob to disconnect the cartridge from the manifold and slide on a new cartridge. Twist the knob back for a tight, secure fit. The manifold contains check valves that close when the cartridge is removed.

All of the AFS Purifiers have very high capacity and can supply multiple GC's for an extended period of time, depending on the laboratory environment.





## AFS Purifier I

The Advanced Filter System I is a high-capacity gas purifying system that removes O<sub>2</sub>, H<sub>2</sub>O, and hydrocarbons (C5 and heavier) from inert gases and hydrogen. It contains a high-sensitivity oxygen and moisture indicator. As shown below, when the cartridge is depleted the oxygen indicator changes from **GREEN** to **GREY** and the moisture indicator changes from **BLUE** to **BROWN**.

cator changes from **GREEN** to **GREY** and the moisture indicator changes from **BLUE** to **BROWN**.

Description	Item No.
AFS Purifier I, 1/8" Fittings, Complete Kit	202900
AFS Purifier I, 1/4" Fittings, Complete Kit	202902
Replacement Cartridge, AFS Purifier I	202910
Reconditioned Cartridge*, AFS Purifier I	202920

*\*Requires exchange of depleted cartridge.*



## AFS Purifier II

The Advanced Filter System II is a high-capacity gas purifying system that removes H<sub>2</sub>O and hydrocarbons (C5 and heavier) from inert gases and hydrogen. It contains a high-sensitivity moisture indicator. As shown below, when the cartridge is depleted the moisture indicator changes from **BLUE** to **BROWN**.

**BLUE** to **BROWN**.

Description	Item No.
AFS Purifier II, 1/8" Fittings, Complete Kit	202903
AFS Purifier II, 1/4" Fittings, Complete Kit	202904
Replacement Cartridge, AFS Purifier II	202950
Reconditioned Cartridge*, AFS Purifier II	202930

*\*Requires exchange of depleted cartridge.*



## AFS Purifier III

The Advanced Filter System III is a high-capacity gas purifying system that removes H<sub>2</sub>O from inert gases and hydrogen. It contains a high-sensitivity moisture indicator. As shown below, when the cartridge is depleted the moisture indicator changes from **BLUE** to **BROWN**.

Description	Item No.
AFS Purifier III, 1/8" Fittings, Complete Kit	202905
AFS Purifier III, 1/4" Fittings, Complete Kit	202906
Replacement Cartridge, AFS Purifier III	202955
Reconditioned Cartridge*, AFS Purifier III	202935

*\*Requires exchange of depleted cartridge.*

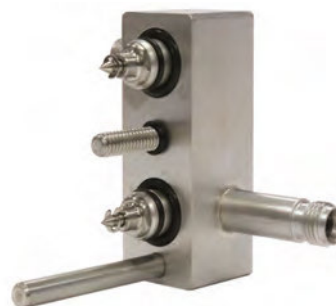

## Manifolds

Description	Item No.
1/8" AFS Purifier Manifold	202900MN
1/4" AFS Purifier Manifold	202902MN

Visit [www.ChromRes.com](http://www.ChromRes.com) for product specifications and additional information.

Filter Indicators shown in both the full capacity and depleted state.



O<sub>2</sub> Adsorbent:  
Top: Full Capacity; Bottom: Depleted.



H<sub>2</sub>O Adsorbent:  
Top: Full Capacity; Bottom: Depleted.



## What is the reconditioning Program?

When your AFS cartridge is depleted, you can return it to CRS for credit towards a reconditioned cartridge. We can restore a depleted cartridge to like-new specifications by refilling it with new adsorbents. You can then order these reconditioned cartridges for a reduced price.

You benefit by paying less for cartridges, while helping the environment by reducing waste and recycling the cartridge body.

## How does it work?

You can order a reconditioned cartridge from CRS at any time. Once you've received the next cartridge, simply ship the original depleted cartridge back to CRS in the box provided. No waiting or instrument downtime!

## Shipping of Hazardous Materials?

In some cases, high quality gas filters with active O<sub>2</sub> or CO<sub>2</sub> adsorbents must be shipped as hazardous goods, even after use. If you are not certified to ship dangerous goods please contact CRS Technical Support.

## Which products are in the program?

CRS currently offers the reconditioning program for all AFS cartridges. This includes the AFS I, II, and III. The ZPure M Filters are also refillable by CRS and are listed on page 14. If you have any questions regarding the reconditioning program please contact CRS Technical Support.

CRS Technical Support  
+ 1.502.491.6300 International  
1.800.327.3800 U.S. Only  
[Sales@ChromRes.com](mailto:Sales@ChromRes.com)

# ZPure™ Inline Gas Filters - Stainless Steel

- High-quality activated adsorbents
- Long purifier life and efficient contaminant removal
- Various size and fitting configurations to fit most existing installations

\*Filter lifetime is dependent on the quality of incoming gas and the flow rate.

\*For more detailed specifications on individual applications please contact CRS at Sales@ChromRes.com.



From Left to Right:  
130 cc, 475 cc, 500 cc, 750 cc.



Compression Fittings seal well and can be broken and retightened many times if used properly. They are compatible with industry standard ferrules and tubing.

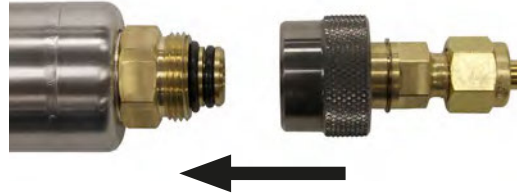

Quick Connect Fittings are used for fast connections and replacements. They have superior seals that use o-rings and check valves to protect gas lines.



Push-to-Connect Fittings are used to connect plastic tubing with a quick and easy connection. They have lower pressure ratings, and permeation through plastic tubing can have some effect on the ultimate purity level of the gas.



## ZPure™ O<sub>2</sub> Filters

The ZPure O<sub>2</sub> Filter removes O<sub>2</sub> from He, Ar, N<sub>2</sub>, H<sub>2</sub>, and methane to low ppb levels with very high capacity. The ZPure O<sub>2</sub> Filter is available with standard compression fittings or quick connect fittings in 1/4" and 1/8" brass and stainless steel.

Visit [www.ChromRes.com](http://www.ChromRes.com) for product specifications and additional information.

[www.ChromRes.com](http://www.ChromRes.com)

### 130 cc Filters

Compression Fittings	Item No.
1/8" Brass Fittings	202216-B
1/8" Stainless Steel Fittings	202216-SS
1/4" Brass Fittings	202217-B
1/4" Stainless Steel Fittings	202217-SS

### Quick Connect Fittings\*

Quick Connect Fittings*	Item No.
1/8" Brass Fittings	202216-B-QC
1/8" Stainless Steel Fittings	202216-SS-QC
1/4" Brass Fittings	202217-B-QC
1/4" Stainless Steel Fittings	202217-SS-QC

\*Replacement Filters listed on page 23.



# Gas Purifiers & Filters



## ZPure™ HC Filters

The ZPure HC Filter removes hydrocarbons (C5 and heavier) from inert gases, He, Ar, N<sub>2</sub>, H<sub>2</sub>, and clean dry air (CDA) to low ppb levels. It is recommended for most applications that require hydrocarbon-free gas, and is available in 4 sizes of stainless steel cylinders ranging from 130 cc to 750 cc. The ZPure HC Filter is available with standard compression fittings and quick connect fittings offered in 1/4" and 1/8" brass and stainless steel, or metal push-to-connect fittings in 1/4" and 6 mm for plastic tubing and non-carrier gas lines.

Visit [www.ChromRes.com](http://www.ChromRes.com) for product specifications and additional information.

### 130 cc Filters

Compression Fittings	Item No.
1/8" Brass Fittings	202232-B
1/8" Stainless Steel Fittings	202232-SS
1/4" Brass Fittings	202233-B
1/4" Stainless Steel Fittings	202233-SS

Quick Connect Fittings*	Item No.
1/8" Brass Fittings	202232-B-QC
1/8" Stainless Steel Fittings	202232-SS-QC
1/4" Brass Fittings	202233-B-QC
1/4" Stainless Steel Fittings	202233-SS-QC

Push-to-Connect Fittings	Item No.
1/4" Nickel Plated Brass Fittings	202232-4-PC
6 mm Nickel Plated Brass Fittings	202232-6-PC

### LS - 475 cc Filters

Compression Fittings	Item No.
1/8" Brass Fittings	202232L-B
1/8" Stainless Steel Fittings	202232L-SS

1/4" Brass Fittings	202233L-B
1/4" Stainless Steel Fittings	202233L-SS

Quick Connect Fittings*	Item No.
1/8" Brass Fittings	202232L-B-QC
1/8" Stainless Steel Fittings	202232L-SS-QC
1/4" Brass Fittings	202233L-B-QC
1/4" Stainless Steel Fittings	202233L-SS-QC

Push-to-Connect Fittings	Item No.
1/4" Nickel Plated Brass Fittings	202232L-4-PC
6 mm Nickel Plated Brass Fittings	202232L-6-PC

### DS - 500 cc Filters

Compression Fittings	Item No.
1/8" Brass Fittings	202232D-B
1/8" Stainless Steel Fittings	202232D-SS
1/4" Brass Fittings	202233D-B
1/4" Stainless Steel Fittings	202233D-SS

Quick Connect Fittings*	Item No.
1/8" Brass Fittings	202232D-B-QC
1/8" Stainless Steel Fittings	202232D-SS-QC
1/4" Brass Fittings	202233D-B-QC
1/4" Stainless Steel Fittings	202233D-SS-QC

Push-to-Connect Fittings	Item No.
1/4" Nickel Plated Brass Fittings	202232D-4-PC
6 mm Nickel Plated Brass Fittings	202232D-6-PC

### XLS - 750 cc Filters

Compression Fittings	Item No.
1/8" Brass Fittings	202232XL-B
1/8" Stainless Steel Fittings	202232XL-SS
1/4" Brass Fittings	202233XL-B
1/4" Stainless Steel Fittings	202233XL-SS

Quick Connect Fittings*	Item No.
1/8" Brass Fittings	202232XL-B-QC
1/8" Stainless Steel Fittings	202232XL-SS-QC
1/4" Brass Fittings	202233XL-B-QC
1/4" Stainless Steel Fittings	202233XL-SS-QC

Push-to-Connect Fittings	Item No.
1/4" Nickel Plated Brass Fittings	202232XL-4-PC
6 mm Nickel Plated Brass Fittings	202232XL-6-PC

\*Replacement Filters listed on page 23.



## ZPure™ H<sub>2</sub>O Filters

The ZPure H<sub>2</sub>O Filter removes H<sub>2</sub>O from inert gases, He, Ar, N<sub>2</sub>, H<sub>2</sub>, methane and clean dry air (CDA) to low ppb levels, with very high capacity. It is recommended for any application that requires ultra-dry gas, and is available in 4 sizes of stainless steel cylinders ranging from 130 cc to 750 cc. The ZPure H<sub>2</sub>O Filter is available with standard compression fittings or quick connect fittings offered in 1/4" and 1/8" brass and stainless steel, or metal push-to-connect fittings in 1/4" and 6 mm for plastic tubing and non-carrier gas lines.

Visit [www.ChromRes.com](http://www.ChromRes.com) for product specifications and additional information.

### 130 cc Filters

Compression Fittings	Item No.
1/8" Brass Fittings	202230-B
1/8" Stainless Steel Fittings	202230-SS
1/4" Brass Fittings	202231-B
1/4" Stainless Steel Fittings	202231-SS

Quick Connect Fittings*	Item No.
1/8" Brass Fittings	202230-B-QC
1/8" Stainless Steel Fittings	202230-SS-QC
1/4" Brass Fittings	202231-B-QC
1/4" Stainless Steel Fittings	202231-SS-QC

Push-to-Connect Fittings	Item No.
1/4" Nickel Plated Brass Fittings	202230-4-PC
6 mm Nickel Plated Brass Fittings	202230-6-PC

### LS - 475 cc Filters

Compression Fittings	Item No.
1/8" Brass Fittings	202230L-B
1/8" Stainless Steel Fittings	202230L-SS

1/4" Brass Fittings	202231L-B
1/4" Stainless Steel Fittings	202231L-SS

Quick Connect Fittings*	Item No.
1/8" Brass Fittings	202230L-B-QC
1/8" Stainless Steel Fittings	202230L-SS-QC
1/4" Brass Fittings	202231L-B-QC
1/4" Stainless Steel Fittings	202231L-SS-QC

Push-to-Connect Fittings	Item No.
1/4" Nickel Plated Brass Fittings	202230L-4-PC
6 mm Nickel Plated Brass Fittings	202230L-6-PC

### DS - 500 cc Filters

Compression Fittings	Item No.
1/8" Brass Fittings	202230D-B
1/8" Stainless Steel Fittings	202230D-SS
1/4" Brass Fittings	202231D-B
1/4" Stainless Steel Fittings	202231D-SS

Quick Connect Fittings*	Item No.
1/8" Brass Fittings	202230D-B-QC
1/8" Stainless Steel Fittings	202230D-SS-QC
1/4" Brass Fittings	202231D-B-QC
1/4" Stainless Steel Fittings	202231D-SS-QC

Push-to-Connect Fittings	Item No.
1/4" Nickel Plated Brass Fittings	202230D-4-PC
6 mm Nickel Plated Brass Fittings	202230D-6-PC

### XLS - 750 cc Filters

Compression Fittings	Item No.
1/8" Brass Fittings	202230XL-B
1/8" Stainless Steel Fittings	202230XL-SS
1/4" Brass Fittings	202231XL-B
1/4" Stainless Steel Fittings	202231XL-SS

Quick Connect Fittings*	Item No.
1/8" Brass Fittings	202230XL-B-QC
1/8" Stainless Steel Fittings	202230XL-SS-QC
1/4" Brass Fittings	202231XL-B-QC
1/4" Stainless Steel Fittings	202231XL-SS-QC

Push-to-Connect Fittings	Item No.
1/4" Nickel Plated Brass Fittings	202230XL-4-PC
6 mm Nickel Plated Brass Fittings	202230XL-6-PC

\*Replacement Filters listed on page 23.

# Gas Purifiers & Filters



## ZPure™ CO<sub>2</sub> Filters

The ZPure CO<sub>2</sub> Filter removes CO<sub>2</sub> from inert gases, He, Ar, N<sub>2</sub>, H<sub>2</sub>, and clean dry air (CDA) to low ppb levels. The filter functions by consuming carbon dioxide in a reaction with highly-dispersed NaOH on a silicate support. The reaction produces water which remains adsorbed in the purifier. In applications where water removal is highly critical, we recommend using an additional moisture trap after the CO<sub>2</sub> Filter. It is available in 4 sizes of stainless steel cylinders ranging from 130 cc to 750 cc. The filter is available with standard compression fittings and quick connect fittings offered in 1/4" and 1/8" brass and stainless steel.

Visit [www.ChromRes.com](http://www.ChromRes.com) for product specifications and additional information.

### 130 cc Filters

Compression Fittings	Item No.
1/8" Brass Fittings	202212-B
1/8" Stainless Steel Fittings	202212-SS
1/4" Brass Fittings	202213-B
1/4" Stainless Steel Fittings	202213-SS

Quick Connect Fittings*	Item No.
1/8" Brass Fittings	202212-B-QC
1/8" Stainless Steel Fittings	202212-SS-QC
1/4" Brass Fittings	202213-B-QC
1/4" Stainless Steel Fittings	202213-SS-QC

### LS - 475 cc Filters

Compression Fittings	Item No.
1/8" Brass Fittings	202212L-B
1/8" Stainless Steel Fittings	202212L-SS
1/4" Brass Fittings	202213L-B
1/4" Stainless Steel Fittings	202213L-SS

Quick Connect Fittings*	Item No.
1/8" Brass Fittings	202212L-B-QC
1/8" Stainless Steel Fittings	202212L-SS-QC
1/4" Brass Fittings	202213L-B-QC
1/4" Stainless Steel Fittings	202213L-SS-QC

### DS - 500 cc Filters

Compression Fittings	Item No.
1/8" Brass Fittings	202212D-B
1/8" Stainless Steel Fittings	202212D-SS
1/4" Brass Fittings	202213D-B
1/4" Stainless Steel Fittings	202213D-SS

Quick Connect Fittings*	Item No.
1/8" Brass Fittings	202212D-B-QC
1/8" Stainless Steel Fittings	202212D-SS-QC
1/4" Brass Fittings	202213D-B-QC
1/4" Stainless Steel Fittings	202213D-SS-QC

### XLS - 750 cc Filters

Compression Fittings	Item No.
1/8" Brass Fittings	202212XL-B
1/8" Stainless Steel Fittings	202212XL-SS
1/4" Brass Fittings	202213XL-B
1/4" Stainless Steel Fittings	202213XL-SS

Quick Connect Fittings*	Item No.
1/8" Brass Fittings	202212XL-B-QC
1/8" Stainless Steel Fittings	202212XL-SS-QC
1/4" Brass Fittings	202213XL-B-QC
1/4" Stainless Steel Fittings	202213XL-SS-QC

\*Replacement Filters listed on page 23.



## ZPure™ O<sub>2</sub>/H<sub>2</sub>O Filters

The ZPure O<sub>2</sub>/H<sub>2</sub>O Filter removes O<sub>2</sub> and H<sub>2</sub>O from inert gases, He, Ar, N<sub>2</sub> and H<sub>2</sub>, making it ideal for use with GC and GC/MS carrier gas lines. It is also recommended for any application requiring ultra-pure gas free from oxygen and moisture. It is available in 4 sizes of stainless steel cylinders ranging from 130 cc to 750 cc. The filter is available with standard compression fittings and quick connect fittings offered in 1/4" and 1/8" brass and stainless steel.

Visit [www.ChromRes.com](http://www.ChromRes.com) for product specifications and additional information.

### 130 cc Filters

Compression Fittings	Item No.
1/8" Brass Fittings	202295-B
1/8" Stainless Steel Fittings	202295-SS
1/4" Brass Fittings	202296-B
1/4" Stainless Steel Fittings	202296-SS

Quick Connect Fittings*	Item No.
1/8" Brass Fittings	202295-B-QC
1/8" Stainless Steel Fittings	202295-SS-QC
1/4" Brass Fittings	202296-B-QC
1/4" Stainless Steel Fittings	202296-SS-QC

### LS - 475 cc Filters

Compression Fittings	Item No.
1/8" Brass Fittings	202295L-B
1/8" Stainless Steel Fittings	202295L-SS
1/4" Brass Fittings	202296L-B
1/4" Stainless Steel Fittings	202296L-SS

Quick Connect Fittings*	Item No.
1/8" Brass Fittings	202295L-B-QC
1/8" Stainless Steel Fittings	202295L-SS-QC
1/4" Brass Fittings	202296L-B-QC
1/4" Stainless Steel Fittings	202296L-SS-QC

### DS - 500 cc Filters

Compression Fittings	Item No.
1/8" Brass Fittings	202295D-B
1/8" Stainless Steel Fittings	202295D-SS
1/4" Brass Fittings	202296D-B
1/4" Stainless Steel Fittings	202296D-SS

Quick Connect Fittings*	Item No.
1/8" Brass Fittings	202295D-B-QC
1/8" Stainless Steel Fittings	202295D-SS-QC
1/4" Brass Fittings	202296D-B-QC
1/4" Stainless Steel Fittings	202296D-SS-QC

### XLS - 750 cc Filters

Compression Fittings	Item No.
1/8" Brass Fittings	202295XL-B
1/8" Stainless Steel Fittings	202295XL-SS
1/4" Brass Fittings	202296XL-B
1/4" Stainless Steel Fittings	202296XL-SS

Quick Connect Fittings*	Item No.
1/8" Brass Fittings	202295XL-B-QC
1/8" Stainless Steel Fittings	202295XL-SS-QC
1/4" Brass Fittings	202296XL-B-QC
1/4" Stainless Steel Fittings	202296XL-SS-QC

\*Replacement Filters listed on page 23.

# Gas Purifiers & Filters



## ZPure™ PolyGas I Purifiers

The ZPure PolyGas I Purifier removes a wide range of contaminants including O<sub>2</sub>, H<sub>2</sub>O, CO<sub>2</sub>, CO, halogenated compounds, siloxanes, hydrocarbons (C5 and heavier), sulfur-containing molecules, ammonia and other gases. It can be used to purify inert gases, He, Ar, N<sub>2</sub>, and H<sub>2</sub>, making it ideal for use with GC and GC/MS carrier gas lines. It is recommended for any application requiring ultra-pure gas free from oxygen, water and hydrocarbons. It is available in 4 sizes of stainless steel cylinders ranging from 130 cc to 750 cc. The ZPure PolyGas I Purifier is available with standard compression fittings and quick connect fittings offered in 1/4" and 1/8" brass and stainless steel.

Visit [www.ChromRes.com](http://www.ChromRes.com) for product specifications and additional information.

### 130 cc Filters

Compression Fittings	Item No.
----------------------	----------

1/8" Brass Fittings	202285-B
1/8" Stainless Steel Fittings	202285-SS
1/4" Brass Fittings	202286-B
1/4" Stainless Steel Fittings	202286-SS

Quick Connect Fittings*	Item No.
-------------------------	----------

1/8" Brass Fittings	202285-B-QC
1/8" Stainless Steel Fittings	202285-SS-QC
1/4" Brass Fittings	202286-B-QC
1/4" Stainless Steel Fittings	202286-SS-QC

### LS - 475 cc Filters

Compression Fittings	Item No.
----------------------	----------

1/8" Brass Fittings	202285L-B
1/8" Stainless Steel Fittings	202285L-SS

1/4" Brass Fittings	202286L-B
1/4" Stainless Steel Fittings	202286L-SS

Quick Connect Fittings*	Item No.
-------------------------	----------

1/8" Brass Fittings	202285L-B-QC
1/8" Stainless Steel Fittings	202285L-SS-QC
1/4" Brass Fittings	202286L-B-QC
1/4" Stainless Steel Fittings	202286L-SS-QC

### DS - 500 cc Filters

Compression Fittings	Item No.
----------------------	----------

1/8" Brass Fittings	202285D-B
1/8" Stainless Steel Fittings	202285D-SS
1/4" Brass Fittings	202286D-B
1/4" Stainless Steel Fittings	202286D-SS

Quick Connect Fittings*	Item No.
-------------------------	----------

1/8" Brass Fittings	202285D-B-QC
1/8" Stainless Steel Fittings	202285D-SS-QC
1/4" Brass Fittings	202286D-B-QC
1/4" Stainless Steel Fittings	202286D-SS-QC

### XLS - 750 cc Filters

Compression Fittings	Item No.
----------------------	----------

1/8" Brass Fittings	202285XL-B
1/8" Stainless Steel Fittings	202285XL-SS
1/4" Brass Fittings	202286XL-B
1/4" Stainless Steel Fittings	202286XL-SS

Quick Connect Fittings*	Item No.
-------------------------	----------

1/8" Brass Fittings	202285XL-B-QC
1/8" Stainless Steel Fittings	202285XL-SS-QC
1/4" Brass Fittings	202286XL-B-QC
1/4" Stainless Steel Fittings	202286XL-SS-QC

\*Replacement Filters listed on page 23.





## ZPure™ PolyGas II Purifiers

The ZPure PolyGas II Purifier removes H<sub>2</sub>O, CO<sub>2</sub>, halogenated compounds, siloxanes, hydrocarbons (C<sub>5</sub> and heavier), sulfur-containing molecules, ammonia and other gases. It can be used to purify inert gases, He, Ar, N<sub>2</sub>, and H<sub>2</sub>, and clean dry air (CDA), to low-ppb levels. A common application is for conditioning the hydrogen and zero air lines used with GC flame ionization detectors. It is available in 4 sizes of stainless steel cylinders ranging from 130 cc to 750 cc. The ZPure PolyGas II Purifier is available with standard compression fittings and quick connect fittings offered in 1/4" and 1/8" brass and stainless steel.

Visit [www.ChromRes.com](http://www.ChromRes.com) for product specifications and additional information.

### 130 cc Filters

Compression Fittings	Item No.
1/8" Brass Fittings	202287-B
1/8" Stainless Steel Fittings	202287-SS
1/4" Brass Fittings	202288-B
1/4" Stainless Steel Fittings	202288-SS

Quick Connect Fittings*	Item No.
1/8" Brass Fittings	202287-B-QC
1/8" Stainless Steel Fittings	202287-SS-QC
1/4" Brass Fittings	202288-B-QC
1/4" Stainless Steel Fittings	202288-SS-QC

### LS - 475 cc Filters

Compression Fittings	Item No.
1/8" Brass Fittings	202287L-B
1/8" Stainless Steel Fittings	202287L-SS
1/4" Brass Fittings	202288L-B
1/4" Stainless Steel Fittings	202288L-SS

Quick Connect Fittings*	Item No.
1/8" Brass Fittings	202287L-B-QC
1/8" Stainless Steel Fittings	202287L-SS-QC
1/4" Brass Fittings	202288L-B-QC
1/4" Stainless Steel Fittings	202288L-SS-QC

### DS - 500 cc Filters

Compression Fittings	Item No.
1/8" Brass Fittings	202287D-B
1/8" Stainless Steel Fittings	202287D-SS
1/4" Brass Fittings	202288D-B
1/4" Stainless Steel Fittings	202288D-SS

Quick Connect Fittings*	Item No.
1/8" Brass Fittings	202287D-B-QC
1/8" Stainless Steel Fittings	202287D-SS-QC
1/4" Brass Fittings	202288D-B-QC
1/4" Stainless Steel Fittings	202288D-SS-QC

### XLS - 750 cc Filters

Compression Fittings	Item No.
1/8" Brass Fittings	202287XL-B
1/8" Stainless Steel Fittings	202287XL-SS
1/4" Brass Fittings	202288XL-B
1/4" Stainless Steel Fittings	202288XL-SS

Quick Connect Fittings*	Item No.
1/8" Brass Fittings	202287XL-B-QC
1/8" Stainless Steel Fittings	202287XL-SS-QC
1/4" Brass Fittings	202288XL-B-QC
1/4" Stainless Steel Fittings	202288XL-SS-QC

\*Replacement Filters listed on page 23.



## DJ's Tech Tips

Vertical mounting of filters gives you more efficient contaminant removal. Media can settle and allow gas to pass over it when they are placed horizontally.

# Gas Purifiers & Filters



Read more about our reconditioning and refilling programs on **page 6**.

## ZPure™ M Filters

The ZPure M Filter is our largest capacity filter. It is a 3.8 L (3800 cc) canister that has the benefit of higher flow rates, and it is CRS-refillable\* at a reduced price. The canister is made from 316 stainless steel and has stainless steel fitting options in 1/2" VCR, 1/4" compression, and 1/4" quick connect fittings.

ZPure M Filters are available in contaminant-specific filters for hydrocarbons, moisture, or carbon dioxide, as well as multi-contaminant versions including an oxygen/moisture filter, and the PolyGas II Purifier.

Visit [www.ChromRes.com](http://www.ChromRes.com) for product specifications and additional information.

\*CRS ZPure M CO<sub>2</sub> is excluded from the reconditioning program. Please contact CRS for instructions on returning all ZPure M canisters for reconditioning by CRS.

### 3800 cc Filters

1/2" VCR Fittings	Item No.
ZPure M HC Filter	202232M-V
ZPure M H <sub>2</sub> O Filter	202230M-V
ZPure M CO <sub>2</sub> Filter	202212M-V
ZPure M PolyGas II Purifier	202287M-V
ZPure O <sub>2</sub> / H <sub>2</sub> O Purifier	202295M-V

1/4" SS Compression Fittings	Item No.
ZPure M HC Filter	202233M-SS
ZPure M H <sub>2</sub> O Filter	202231M-SS
ZPure M CO <sub>2</sub> Filter	202213M-SS
ZPure M PolyGas II Purifier	202288M-SS
ZPure O <sub>2</sub> / H <sub>2</sub> O Purifier	202296M-SS



1/2" VCR Fittings

1/4" SS Quick Connect Fittings	Item No.
ZPure M HC Filter	202233M-SS-QC
ZPure M H <sub>2</sub> O Filter	202231M-SS-QC
ZPure M CO <sub>2</sub> Filter	202213M-SS-QC
ZPure M PolyGas II Purifier	202288M-SS-QC
ZPure O <sub>2</sub> / H <sub>2</sub> O Purifier	202296M-SS-QC

# ZPure™ Inline Gas Filters - Glass Indicating

- A range of convenient point-of-use purifiers for many applications, with high-sensitivity visual indicators for oxygen and water breakthrough
- Outer polycarbonate tube isolates the gas stream if the inner glass tube should break
- High capacity adsorbents with consistent performance
- Integrated stainless steel frits for particle removal
- Fluoroelastomer seals for inertness
- Individually helium leak-tested
- Available with compression and quick connect fittings

\*Filter lifetime is dependent on the quality of incoming gas and the flow rate.

\*For more detailed specifications on individual applications please contact CRS at [Sales@ChromRes.com](mailto:Sales@ChromRes.com).



Compression Fittings seal well and can be broken and retightened many times if used properly. They are compatible with industry standard ferrules and tubing.

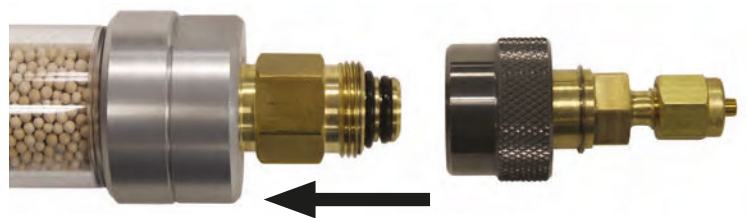

Quick Connect Fittings are used for fast connections and replacements. They have superior seals that use O-rings and check valves to protect gas lines.

Filter Indicators shown in full capacity and depleted states.



Oxygen Adsorbent:  
Top: Full Capacity; Bottom: Depleted.



Moisture Adsorbent:  
Top: Full Capacity; Bottom: Depleted.



CoFree™ Adsorbent:  
Top: Full Capacity; Bottom: Depleted.

# Gas Purifiers & Filters



## ZPure™ Glass PolyGas I Purifiers

The ZPure PolyGas I Purifier removes O<sub>2</sub>, H<sub>2</sub>O, CO<sub>2</sub>, CO, halogenated compounds, siloxanes, hydrocarbons (C5 and heavier), sulfur-containing molecules, and ammonia from inert gases, He, Ar, N<sub>2</sub> and H<sub>2</sub>. It can be used to provide end-point detection for use with other ZPure Filters. The indicators signal oxygen breakthrough when the adsorbent changes from **GREEN** to **GREY** and the moisture indicator changes from **BLUE** to **BROWN**. The ZPure Glass Filters and Purifiers are available with standard compression fittings or quick connect fittings in 1/4" and 1/8" brass and stainless steel.

Visit [www.ChromRes.com](http://www.ChromRes.com) for product specifications and additional information.

### 38 cc Filters

Compression Fittings	Item No.
1/8" Brass Fittings	202314-B
1/8" Stainless Steel Fittings	202314-SS
1/4" Brass Fittings	202315-B
1/4" Stainless Steel Fittings	202315-SS

Quick Connect Fittings*	Item No.
1/8" Brass Fittings	202314-B-QC
1/8" Stainless Steel Fittings	202314-SS-QC
1/4" Brass Fittings	202315-B-QC
1/4" Stainless Steel Fittings	202315-SS-QC

\*Replacement Filters listed on page 24.



## ZPure™ Glass PolyGas II Purifiers

The ZPure PolyGas II Purifier removes H<sub>2</sub>O, CO<sub>2</sub>, halogenated compounds, siloxanes, hydrocarbons (C5 and heavier), sulfur-containing molecules, and ammonia from inert gases, He, Ar, N<sub>2</sub>, H<sub>2</sub>, and clean dry air (CDA). It can be used to provide end-point detection for use with other ZPure Filters. The moisture indicator signals breakthrough when it changes from **BLUE** to **BROWN**. The ZPure Glass Filters and Purifiers are available with standard compression fittings or quick connect fittings in 1/4" and 1/8" brass and stainless steel.

Visit [www.ChromRes.com](http://www.ChromRes.com) for product specifications and additional information.

### 38 cc Filters

Compression Fittings	Item No.
1/8" Brass Fittings	202318-B
1/8" Stainless Steel Fittings	202318-SS
1/4" Brass Fittings	202319-B
1/4" Stainless Steel Fittings	202319-SS

Quick Connect Fittings*	Item No.
1/8" Brass Fittings	202318-B-QC
1/8" Stainless Steel Fittings	202318-SS-QC
1/4" Brass Fittings	202319-B-QC
1/4" Stainless Steel Fittings	202319-SS-QC

\*Replacement Filters listed on page 24.



## ZPure™ Glass O<sub>2</sub> Filters

The ZPure O<sub>2</sub> Filter removes O<sub>2</sub> to low ppb levels from He, Ar, N<sub>2</sub>, or methane. The indicator signals oxygen breakthrough when the adsorbent changes from **GREEN** to **GREY**. The ZPure Glass Filters and Purifiers are available with standard compression fittings or quick connect fittings in 1/4" and 1/8" brass and stainless steel.

Visit [www.ChromRes.com](http://www.ChromRes.com) for product specifications and additional information.

### 10 cc Filters

Compression Fittings	Item No.
1/8" Brass Fittings	202236-B
1/8" Stainless Steel Fittings	202236-SS
1/4" Brass Fittings	202237-B
1/4" Stainless Steel Fittings	202237-SS

Quick Connect Fittings*	Item No.
1/8" Brass Fittings	202236-B-QC
1/8" Stainless Steel Fittings	202236-SS-QC
1/4" Brass Fittings	202237-B-QC
1/4" Stainless Steel Fittings	202237-SS-QC

\*Replacement Filters listed on page 24.



## ZPure™ Glass H<sub>2</sub>O HSMI Filters

The ZPure H<sub>2</sub>O HSMI Filter is for applications requiring high efficiency H<sub>2</sub>O removal. The high sensitivity indicator signals breakthrough at 1 ppm H<sub>2</sub>O and changes from **BLUE** to **BROWN**. The ZPure Glass Filters and Purifiers are available with standard compression fittings or quick connect fittings in 1/4" and 1/8" brass and stainless steel.

Visit [www.ChromRes.com](http://www.ChromRes.com) for product specifications and additional information.

### 46 cc Filters

Compression Fittings	Item No.
1/8" Brass Fittings	202283-B
1/8" Stainless Steel Fittings	202283-SS
1/4" Brass Fittings	202284-B
1/4" Stainless Steel Fittings	202284-SS

Quick Connect Fittings*	Item No.
1/8" Brass Fittings	202283-B-QC
1/8" Stainless Steel Fittings	202283-SS-QC
1/4" Brass Fittings	202284-B-QC
1/4" Stainless Steel Fittings	202284-SS-QC

\*Replacement Filters listed on page 24.



**BLOGables**

Need help picking an indicator? Read more online at <https://www.ChromRes.com/blog/>

Useful and relevant discussions related to the GC industry including product information, troubleshooting, FAQ, and recommendations from our skilled experts.



# Gas Purifiers & Filters



## ZPure™ Glass H<sub>2</sub>O Filters

The ZPure H<sub>2</sub>O Filter removes H<sub>2</sub>O to low ppb levels. The Co-Free H<sub>2</sub>O indicator signals breakthrough at 5% relative humidity and changes from **GREEN** to **BLUE**. The ZPure Glass Filters and Purifiers are available with standard compression fittings or quick connect fittings in 1/4" and 1/8" brass and stainless steel.

Visit [www.ChromRes.com](http://www.ChromRes.com) for product specifications and additional information.

### 46 cc Filters

Compression Fittings	Item No.
1/8" Brass Fittings	202234-B
1/8" Stainless Steel Fittings	202234-SS
1/4" Brass Fittings	202235-B
1/4" Stainless Steel Fittings	202235-SS

Quick Connect Fittings*	Item No.
1/8" Brass Fittings	202234-B-QC
1/8" Stainless Steel Fittings	202234-SS-QC
1/4" Brass Fittings	202235-B-QC
1/4" Stainless Steel Fittings	202235-SS-QC

\*Replacement Filters listed on page 24.



## ZPure™ Glass H<sub>2</sub>O / HC Filters

The ZPure H<sub>2</sub>O / HC Filter removes H<sub>2</sub>O and hydrocarbons (C5 and heavier) from dry air or inert gases. The Co-Free H<sub>2</sub>O indicator signals breakthrough at 5% relative humidity and changes from **GREEN** to **BLUE**. The ZPure Glass H<sub>2</sub>O / HC Filter is available with standard compression fittings or quick connect fittings in 1/4" and 1/8" brass and stainless steel.

Visit [www.ChromRes.com](http://www.ChromRes.com) for product specifications and additional information.

### 46 cc Filters

Compression Fittings	Item No.
1/8" Brass Fittings	202256-B
1/8" Stainless Steel Fittings	202256-SS
1/4" Brass Fittings	202257-B
1/4" Stainless Steel Fittings	202257-SS

Quick Connect Fittings*	Item No.
1/8" Brass Fittings	202256-B-QC
1/8" Stainless Steel Fittings	202256-SS-QC
1/4" Brass Fittings	202257-B-QC
1/4" Stainless Steel Fittings	202257-SS-QC

\*Replacement Filters listed on page 24.



## Did you know?

You can contact CRS for filter life estimations based on your specific laboratory environment.

# SPure™ Inline Gas Filters - Plastic Body

- Moisture, oil, dust and hydrocarbon traps suitable for general purpose use
- High-strength polycarbonate and acrylic bodies with aluminum endcaps
- Available with standard brass and stainless steel compression fittings, quick connect fittings, and metal push-to-connect fittings
- Not recommended for house compressed air lines or for GC Carrier gases
- Not for use with hazardous, flammable, or reactive gases

\*Filter lifetime is dependent on the quality of incoming gas and the flow rate.

\*For more detailed specifications on individual applications please contact CRS at Sales@ChromRes.com.

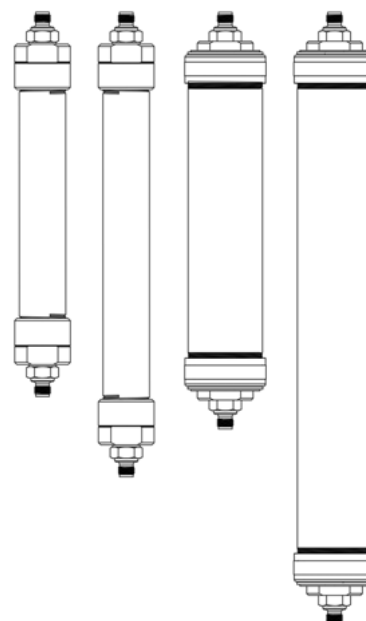

From Left to Right:  
88 cc, 116 cc, 240 cc, 400 cc.



Compression Fittings seal well and can be broken and retightened many times if used properly. Compatible with industry standard ferrules and tubing.

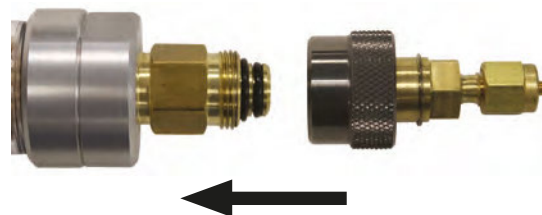

Quick Connect Fittings are used for fast connections and replacements. They have superior seals that use O-rings and check valves to protect gas lines.



Push-to-Connect Fittings are used to connect plastic tubing with a quick and easy connection. Push-to-connect fittings have lower pressure ratings, and permeation through plastic tubing can have some effect on the ultimate purity level of the gas.

Filter Indicators shown in full capacity and depleted states.



CoFree™ Adsorbent:  
Top: Full Capacity; Bottom: Depleted.

# Gas Purifiers & Filters

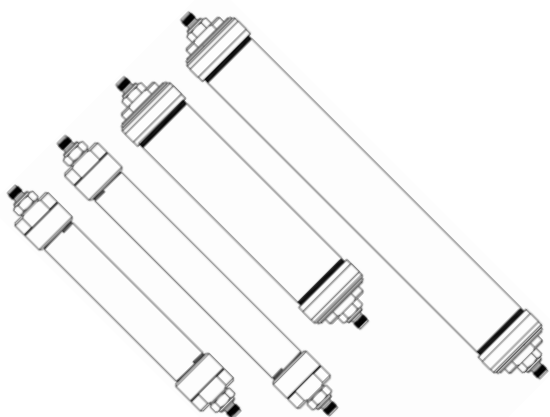

## SPure™ H<sub>2</sub>O Filters

The SPure H<sub>2</sub>O Filter removes moisture, oil and dust from air and inert gases. The cobalt-free moisture indicator signals breakthrough at 5% relative humidity and changes from **GREEN** to **BLUE**. The SPure H<sub>2</sub>O Filter is available in an 88 cc tube, a long 116 cc tube, a 240 cc tube, and an extra large 400 cc tube (shown above from left to right). SPure Filters have the option of standard compression fittings and quick connect fittings in 1/4" and 1/8" brass and stainless steel, or metal push-to-connect fittings in 1/4" and 6 mm for plastic tubing and non-carrier gas lines.

Visit [www.ChromRes.com](http://www.ChromRes.com) for product specifications and additional information.

### 88 cc Filters

Compression Fittings	Item No.
1/8" Brass Fittings	202238-B
1/8" Stainless Steel Fittings	202238-SS
1/4" Brass Fittings	202239-B
1/4" Stainless Steel Fittings	202239-SS

Quick Connect Fittings*	Item No.
1/8" Brass Fittings	202238-B-QC
1/8" Stainless Steel Fittings	202238-SS-QC
1/4" Brass Fittings	202239-B-QC
1/4" Stainless Steel Fittings	202239-SS-QC

Push-to-Connect Fittings	Item No.
1/4" Nickel Plated Brass Fittings	202238-4-PC
6 mm Nickel Plated Brass Fittings	202238-6-PC

### LS - 116 cc Filters

Compression Fittings	Item No.
1/8" Brass Fittings	202238L-B
1/8" Stainless Steel Fittings	202238L-SS

1/4" Brass Fittings	202239L-B
1/4" Stainless Steel Fittings	202239L-SS

Quick Connect Fittings*	Item No.
1/8" Brass Fittings	202238L-B-QC
1/8" Stainless Steel Fittings	202238L-SS-QC
1/4" Brass Fittings	202239L-B-QC
1/4" Stainless Steel Fittings	202239L-SS-QC

Push-to-Connect Fittings	Item No.
1/4" Nickel Plated Brass Fittings	202238L-4-PC
6 mm Nickel Plated Brass Fittings	202238L-6-PC

### DS - 240 cc Filters

Compression Fittings	Item No.
1/8" Brass Fittings	202238D-B
1/8" Stainless Steel Fittings	202238D-SS
1/4" Brass Fittings	202239D-B
1/4" Stainless Steel Fittings	202239D-SS

Quick Connect Fittings*	Item No.
1/8" Brass Fittings	202238D-B-QC
1/8" Stainless Steel Fittings	202238D-SS-QC
1/4" Brass Fittings	202239D-B-QC
1/4" Stainless Steel Fittings	202239D-SS-QC

Push-to-Connect Fittings	Item No.
1/4" Nickel Plated Brass Fittings	202238D-4-PC
6 mm Nickel Plated Brass Fittings	202238D-6-PC

### XLS - 400 cc Filters

Compression Fittings	Item No.
1/8" Brass Fittings	202238XL-B
1/8" Stainless Steel Fittings	202238XL-SS
1/4" Brass Fittings	202239XL-B
1/4" Stainless Steel Fittings	202239XL-SS

Quick Connect Fittings*	Item No.
1/8" Brass Fittings	202238XL-B-QC
1/8" Stainless Steel Fittings	202238XL-SS-QC
1/4" Brass Fittings	202239XL-B-QC
1/4" Stainless Steel Fittings	202239XL-SS-QC

Push-to-Connect Fittings	Item No.
1/4" Nickel Plated Brass Fittings	202238XL-4-PC
6 mm Nickel Plated Brass Fittings	202238XL-6-PC

\*Replacement Filters listed on page 24.

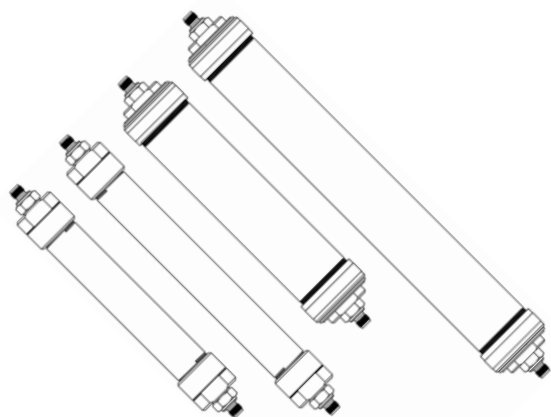

## SPure™ H<sub>2</sub>O/HC Filters

The SPure H<sub>2</sub>O/HC Filter removes moisture, oil, dust, and hydrocarbons (C5 and heavier) from dry air and inert gases. The cobalt-free moisture indicator signals breakthrough at 5% relative humidity and changes from **GREEN** to **BLUE**. The SPure H<sub>2</sub>O/HC Filter is available in an 88 cc tube, a long 116 cc tube, a 240 cc tube, and an extra large 400 cc tube (shown above from left to right). SPure Filters have the option of standard compression fittings and quick connect fittings in 1/4" and 1/8" brass and stainless steel, or metal push-to-connect fittings in 1/4" and 6 mm for plastic tubing and non-carrier gas lines.

Visit [www.ChromRes.com](http://www.ChromRes.com) for product specifications and additional information.

### 88 cc Filters

Compression Fittings	Item No.
1/8" Brass Fittings	202324-B
1/8" Stainless Steel Fittings	202324-SS
1/4" Brass Fittings	202325-B
1/4" Stainless Steel Fittings	202325-SS

Quick Connect Fittings*	Item No.
1/8" Brass Fittings	202324-B-QC
1/8" Stainless Steel Fittings	202324-SS-QC
1/4" Brass Fittings	202325-B-QC
1/4" Stainless Steel Fittings	202325-SS-QC

Push-to-Connect Fittings	Item No.
1/4" Nickel Plated Brass Fittings	202324-4-PC
6 mm Nickel Plated Brass Fittings	202324-6-PC

### LS - 116 cc Filters

Compression Fittings	Item No.
1/8" Brass Fittings	202324L-B
1/8" Stainless Steel Fittings	202324L-SS

[www.ChromRes.com](http://www.ChromRes.com)

1/4" Brass Fittings	202325L-B
1/4" Stainless Steel Fittings	202325L-SS

Quick Connect Fittings*	Item No.
1/8" Brass Fittings	202324L-B-QC
1/8" Stainless Steel Fittings	202324L-SS-QC
1/4" Brass Fittings	202325L-B-QC
1/4" Stainless Steel Fittings	202325L-SS-QC

Push-to-Connect Fittings	Item No.
1/4" Nickel Plated Brass Fittings	202324L-4-PC
6 mm Nickel Plated Brass Fittings	202324L-6-PC

### DS - 240 cc Filters

Compression Fittings	Item No.
1/8" Brass Fittings	202324D-B
1/8" Stainless Steel Fittings	202324D-SS
1/4" Brass Fittings	202325D-B
1/4" Stainless Steel Fittings	202325D-SS

Quick Connect Fittings*	Item No.
1/8" Brass Fittings	202324D-B-QC
1/8" Stainless Steel Fittings	202324D-SS-QC
1/4" Brass Fittings	202325D-B-QC
1/4" Stainless Steel Fittings	202325D-SS-QC

Push-to-Connect Fittings	Item No.
1/4" Nickel Plated Brass Fittings	202324D-4-PC
6 mm Nickel Plated Brass Fittings	202324D-6-PC

### XLS - 400 cc Filters

Compression Fittings	Item No.
1/8" Brass Fittings	202324XL-B
1/8" Stainless Steel Fittings	202324XL-SS
1/4" Brass Fittings	202325XL-B
1/4" Stainless Steel Fittings	202325XL-SS

Quick Connect Fittings*	Item No.
1/8" Brass Fittings	202324XL-B-QC
1/8" Stainless Steel Fittings	202324XL-SS-QC
1/4" Brass Fittings	202325XL-B-QC
1/4" Stainless Steel Fittings	202325XL-SS-QC

Push-to-Connect Fittings	Item No.
1/4" Nickel Plated Brass Fittings	202324XL-4-PC
6 mm Nickel Plated Brass Fittings	202324XL-6-PC

\*Replacement Filters listed on page 24.

# Gas Purifiers & Filters

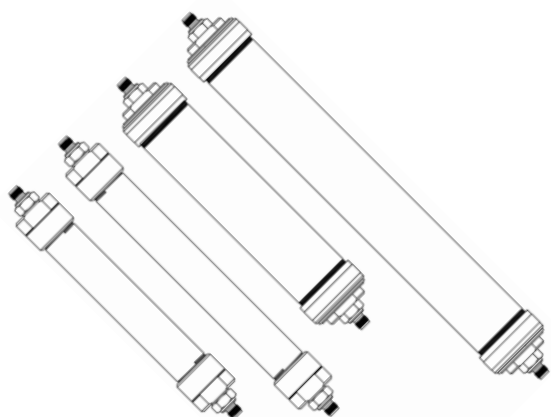

## SPure™ HC Filters

The SPure HC Filter removes hydrocarbons (C5 and heavier) from dry air and inert gases. The SPure HC Filter is available in an 88 cc tube, a long 116 cc tube, a 240 cc tube, and an extra large 400 cc tube (shown above from left to right). SPure Filters have the option of standard compression fittings and quick connect fittings in 1/4" and 1/8" brass and stainless steel, or metal push-to-connect fittings in 1/4" and 6 mm for plastic tubing and non-carrier gas lines.

Visit [www.ChromRes.com](http://www.ChromRes.com) for product specifications and additional information.

### 88 cc Filters

Compression Fittings	Item No.
1/8" Brass Fittings	202326-B
1/8" Stainless Steel Fittings	202326-SS
1/4" Brass Fittings	202327-B
1/4" Stainless Steel Fittings	202327-SS

Quick Connect Fittings*	Item No.
1/8" Brass Fittings	202326-B-QC
1/8" Stainless Steel Fittings	202326-SS-QC
1/4" Brass Fittings	202327-B-QC
1/4" Stainless Steel Fittings	202327-SS-QC

Push-to-Connect Fittings	Item No.
1/4" Nickel Plated Brass Fittings	202326-4-PC
6 mm Nickel Plated Brass Fittings	202326-6-PC

### LS - 116 cc Filters

Compression Fittings	Item No.
1/8" Brass Fittings	202326L-B
1/8" Stainless Steel Fittings	202326L-SS

1/4" Brass Fittings	202327L-B
1/4" Stainless Steel Fittings	202327L-SS

Quick Connect Fittings*	Item No.
1/8" Brass Fittings	202326L-B-QC
1/8" Stainless Steel Fittings	202326L-SS-QC
1/4" Brass Fittings	202327L-B-QC
1/4" Stainless Steel Fittings	202327L-SS-QC

Push-to-Connect Fittings	Item No.
1/4" Nickel Plated Brass Fittings	202326L-4-PC
6 mm Nickel Plated Brass Fittings	202326L-6-PC

### DS - 240 cc Filters

Compression Fittings	Item No.
1/8" Brass Fittings	202326D-B
1/8" Stainless Steel Fittings	202326D-SS
1/4" Brass Fittings	202327D-B
1/4" Stainless Steel Fittings	202327D-SS

Quick Connect Fittings*	Item No.
1/8" Brass Fittings	202326D-B-QC
1/8" Stainless Steel Fittings	202326D-SS-QC
1/4" Brass Fittings	202327D-B-QC
1/4" Stainless Steel Fittings	202327D-SS-QC

Push-to-Connect Fittings	Item No.
1/4" Nickel Plated Brass Fittings	202326D-4-PC
6 mm Nickel Plated Brass Fittings	202326D-6-PC

### XLS - 400 cc Filters

Compression Fittings	Item No.
1/8" Brass Fittings	202326XL-B
1/8" Stainless Steel Fittings	202326XL-SS
1/4" Brass Fittings	202327XL-B
1/4" Stainless Steel Fittings	202327XL-SS

Quick Connect Fittings*	Item No.
1/8" Brass Fittings	202326XL-B-QC
1/8" Stainless Steel Fittings	202326XL-SS-QC
1/4" Brass Fittings	202327XL-B-QC
1/4" Stainless Steel Fittings	202327XL-SS-QC

Push-to-Connect Fittings	Item No.
1/4" Nickel Plated Brass Fittings	202326XL-4-PC
6 mm Nickel Plated Brass Fittings	202326XL-6-PC

\*Replacement Filters listed on page 24.



# Quick Connect Cartridge Replacements

Quick Connect Fittings are used for fast connections and replacements. Once you have ordered a filter with a quick connect fittings kit, you can then order replacement cartridges at a reduced price. They have superior seals that use o-rings and check valves to protect gas lines.

Visit [www.ChromRes.com](http://www.ChromRes.com) for product specifications and additional information.



## ZPure™ Stainless Steel Filter Quick Connect Cartridge Replacements



O <sub>2</sub> Filters	Brass Fitting Kits	SS Fitting Kits
130 cc Filter	202RO2-B-QC	202RO2-SS-QC

H <sub>2</sub> O Filters	Brass Fitting Kits	SS Fitting Kits
130 cc Filter	202RH2-B-QC	202RH2-SS-QC
475 cc Filter	202RH2L-B-QC	202RH2L-SS-QC
500 cc Filter	202RH2D-B-QC	202RH2D-SS-QC
750 cc Filter	202RH2XL-B-QC	202RH2XL-SS-QC

HC Filters	Brass Fitting Kits	SS Fitting Kits
130 cc Filter	202RHC-B-QC	202RHC-SS-QC
475 cc Filter	202RHCL-B-QC	202RHCL-SS-QC
500 cc Filter	202RHCD-B-QC	202RHCD-SS-QC
750 cc Filter	202RHCXL-B-QC	202RHCXL-SS-QC

O <sub>2</sub> / H <sub>2</sub> O Filters	Brass Fitting Kits	SS Fitting Kits
130 cc Filter	202ROH-B-QC	202ROH-SS-QC
475 cc Filter	202ROHL-B-QC	202ROHL-SS-QC
500 cc Filter	202ROHD-B-QC	202ROHD-SS-QC
750 cc Filter	202ROHXL-B-QC	202ROHXL-SS-QC

CO <sub>2</sub> Filters	Brass Fitting Kits	SS Fitting Kits
130 cc Filter	202RCO-B-QC	202RCO-SS-QC
475 cc Filter	202RCOL-B-QC	202RCOL-SS-QC
500 cc Filter	202RCOD-B-QC	202RCOD-SS-QC
750 cc Filter	202RCOXL-B-QC	202RCOXL-SS-QC

PolyGas I	Brass Fitting Kits	SS Fitting Kits
130 cc Filter	202RP1-B-QC	202RP1-SS-QC
475 cc Filter	202RP1L-B-QC	202RP1L-SS-QC
500 cc Filter	202RP1D-B-QC	202RP1D-SS-QC
750 cc Filter	202RP1XL-B-QC	202RP1XL-SS-QC

PolyGas II	Brass Fitting Kits	SS Fitting Kits
130 cc Filter	202RP2-B-QC	202RP2-SS-QC
475 cc Filter	202RP2L-B-QC	202RP2L-SS-QC
500 cc Filter	202RP2D-B-QC	202RP2D-SS-QC
750 cc Filter	202RP2XL-B-QC	202RP2XL-SS-QC



### Did you know?

Our quality leak checks guarantee ultra-high purity outlet gas.

## Quick Connect Cartridge Replacements

Quick Connect Fittings are used for fast connections and replacements. Once you have ordered a filter with a quick connect fittings kit, you can then order replacement cartridges at a reduced price. They have superior seals that use o-rings and check valves to protect gas lines.

Visit [www.ChromRes.com](http://www.ChromRes.com) for product specifications and additional information.



### ZPure™ Glass Filter Quick Connect Cartridge Replacements



PolyGas I	Brass Fitting Kits	SS Fitting Kits
38 cc Purifier	202314RP-B-QC	202314RP-SS-QC

PolyGas II	Brass Fitting Kits	SS Fitting Kits
38 cc Purifier	202318RP-B-QC	202318RP-SS-QC

O <sub>2</sub>	Brass Fitting Kits	SS Fitting Kits
10 cc Filter	202236RP-B-QC	202236RP-SS-QC

H <sub>2</sub> O HSMI	Brass Fitting Kits	SS Fitting Kits
46 cc Filter	202283RP-B-QC	202283RP-SS-QC

H <sub>2</sub> O	Brass Fitting Kits	SS Fitting Kits
46 cc Filter	202234RP-B-QC	202234RP-SS-QC

H <sub>2</sub> O / HC	Brass Fitting Kits	SS Fitting Kits
46 cc Filter	202256RP-B-QC	202256RP-SS-QC

### SPure™ Filter Quick Connect Cartridge Replacements



SPure H <sub>2</sub> O	Brass Fitting Kits	SS Fitting Kits
88 cc Filter	202238RP-B-QC	202238RP-SS-QC
116 cc Filter	202238LRP-B-QC	202238LRP-SS-QC
240 cc Filter	202238DRP-B-QC	202238DRP-SS-QC
400 cc Filter	202238XLRP-B-QC	202238XLRP-SS-QC

SPure H <sub>2</sub> O/HC	Brass Fitting Kits	SS Fitting Kits
88 cc Filter	202324RP-B-QC	202324RP-SS-QC
116 cc Filter	202324LRP-B-QC	202324LRP-SS-QC
240 cc Filter	202324DRP-B-QC	202324DRP-SS-QC
400 cc Filter	202324XLRP-B-QC	202324XLRP-SS-QC

SPure HC	Brass Fitting Kits	SS Fitting Kits
88 cc Filter	202326RP-B-QC	202326RP-SS-QC
116 cc Filter	202326LRP-B-QC	202326LRP-SS-QC
240 cc Filter	202326DRP-B-QC	202326DRP-SS-QC
400 cc Filter	202326XLRP-B-QC	202326XLRP-SS-QC

# CRS Legacy Purifiers

CRS has several standard inline purifiers that are known as the Legacy Line. They are sturdy metal cylinders that are recognized for their high pressure ratings, large capacities, and exceptional efficiency. The Legacy Line includes contaminant-specific models for removal of oxygen, moisture, hydrocarbons, and carbon dioxide from the gas stream. The Stainless Steel ZPure Filters are recommended as upgrades to these purifiers.

\*Purifier lifetime is dependent on the quality of incoming gas and the flow rate.

\*For more detailed specifications on individual applications please contact CRS at Sales@ChromRes.com.



## Model 1000 Oxygen Purifiers

The Model 1000 is a high capacity O<sub>2</sub> filter, for long term protection of capillary column stationary phases against oxidation at GC operating temperatures. The Model 1000 is intended for use with non-oxidizing gases such as He, Ar, N<sub>2</sub>, H<sub>2</sub> or CH<sub>4</sub>, containing less than 0.1% oxygen. The adsorbent binds covalently with oxygen; no gas is generated from this reaction. The filters are available with standard compression fittings in 1/4" and 1/8" nickel-plated brass.

Visit [www.ChromRes.com](http://www.ChromRes.com) for product specifications and additional information.

### 500 cc

Compression Fittings	Item No.
1/8" Nickel-Plated Brass Fittings	202200
1/4" Nickel-Plated Brass Fittings	202202

## Model 500 Molecular Sieve Drying Purifiers

The Model 500 is a high capacity H<sub>2</sub>O filter that reduces moisture to low ppb levels. It is recommended for detector support gases and carrier gases. The filters are available with standard compression fittings in 1/4" and 1/8" nickel-plated brass.

Visit [www.ChromRes.com](http://www.ChromRes.com) for product specifications and additional information.

### 500 cc

Compression Fittings	Item No.
1/8" Nickel-Plated Brass Fittings	202270
1/4" Nickel-Plated Brass Fittings	202272

# Gas Purifiers & Filters



## Did you know?

CRS developed the ZPure Line as an upgrade to the Legacy Purifiers? ZPure Filters and Purifiers have improved safety features, advanced sealing technology, and various size and fitting configurations.



## Model 300 High Pressure Hydrocarbon Purifiers

The Model 300 Purifier is a high capacity HC filter that removes hydrocarbons (C5 and heavier) to low ppb levels. It can be used for your FID air and H<sub>2</sub> lines to minimize noise and extraneous peaks in the signal. It is also recommended for use with purge and trap apparatuses, and with GC carrier gases for trace analysis. The filters are available with standard compression fittings in 1/4" and 1/8" nickel-plated brass.

Visit [www.ChromRes.com](http://www.ChromRes.com) for product specifications and additional information.

500 cc

Compression Fittings	Item No.
1/8" Nickel-Plated Brass Fittings	202330
1/4" Nickel-Plated Brass Fittings	202332



## Carbon Dioxide Purifiers

The Carbon Dioxide Purifier is a high capacity filter that removes CO<sub>2</sub> from the gas stream to low ppb levels. This filter will irreversibly bind the CO<sub>2</sub>; the reaction will create moisture which is adsorbed by the molecular sieve. When downstream water is a concern, it is recommended to use a second moisture purifier in line as well. The Carbon Dioxide Purifier is not recommended for GC use. The filters are available with standard compression fittings in 1/4" and 1/8" nickel-plated brass.

Visit [www.ChromRes.com](http://www.ChromRes.com) for product specifications and additional information.

500 cc

Compression Fittings	Item No.
1/8" Nickel-Plated Brass Fittings	202350
1/4" Nickel-Plated Brass Fittings	202352

# ZPure™

The most reliable brand  
in gas filters.

Now in 5 sizes for quick  
drop-in replacements of  
leading competitors.

Condense your filter  
program to one  
vendor that has  
everything you need!

**crs** | Chromatography  
Research Supplies







**Over 25 Years of Experience**  
makes us a trusted source for  
environmental labs. Let our experts  
and high-quality chromatography  
products assist in your analysis.





# Ferrules

Graphite Ferrules . . . . .	30-32
Vespel® Ferrules . . . . .	33-34
Vespel®/Graphite Ferrules (60% / 40%) . . . . .	35-36
Vespel®/Graphite Ferrules (85% / 15%) . . . . .	37-38
PTFE Ferrules . . . . .	39

# Ferrules

## Graphite Ferrules

Graphite ferrules are made from high-purity exfoliated graphite. They seal with minimal torque and can frequently be re-used. They do not shrink in use, but they are very soft and must be packed and handled carefully.



Straight Ferrules - for tubing with ODs listed	Item No
1/16", 10/pk	211100
1/8", 10/pk	211200
1/4", 10/pk	211400
3/8", 10/pk	211600
1/2", 5/pk	211800
3/4", 5/pk	211120



Blank Ferrules - no holes	Item No
1/16", 10/pk	2111XX
1/8", 10/pk	2112XX
1/4", 10/pk	2114XX



Capillary Column Ferrules	For Capillary Sizes - ID	Item No
1/16" to 0.4 mm, 10/pk	0.25 mm	211104
1/16" to 0.5 mm, 10/pk	0.32 mm	211105
1/16" to 0.8 mm, 10/pk	0.53 mm	211108
1/16" to 1.0 mm, 10/pk	0.65 mm	211110
1/16" to 1.2 mm, 10/pk	0.75 mm	211112
1/16", two hole 0.5 mm; each	0.32 mm	211125



Short Ferrules for Agilent Inlets*	For Capillary Sizes - ID	Item No
1/16" to 0.4 mm, 10/pk	0.10 - 0.25 mm	211164
1/16" to 0.5 mm, 10/pk	0.32 mm	211165
1/16" to 0.8 mm, 10/pk	0.45 - 0.53 mm	211168
1/16" to 1.0 mm, 10/pk	0.53 - 0.65 mm	211160

\*short ferrules for Agilent inlet systems: 5890, 6890 and 7890.



1/16" to 1/16" Straight Ferrule, 10/pk	1/16" OD	211170
--	----------	--------



Reducing Ferrules for Capillary Columns	For Capillary Sizes - ID	Item No
1/8" to 0.4 mm, 10/pk	0.25 mm	211204
1/8" to 0.5 mm, 10/pk	0.32 mm	211205
1/8" to 0.8 mm, 10/pk	0.53 mm	211208
1/8", two hole 0.5 mm; each	0.32 mm	211222
1/4" to 0.5 mm, 10/pk	0.32 mm	211405
1/4" to 0.8 mm, 10/pk	0.53 mm	211408



Reducing Ferrules for Tubing	For Tubing Sizes - OD	Item No
1/8" to 1/16", 10/pk	1/16"	211210
1/4" to 4 mm, 10/pk	4 mm	211440
1/4" to 6 mm, 10/pk	6 mm	211406
1/4" to 1/16", 10/pk	1/16"	211410
1/4" to 1/8", 10/pk	1/8"	211420



Shimadzu Ferrule	Item No
5 mm, Shimadzu 5 mm OD columns, 10/pk	211500



Shimadzu Capillary Column Ferrules	For Capillary Sizes - ID	Item No
Shimadzu 17A, 2010 & 2014 GCs 0.4 mm, 10/pk	0.25 mm and less	211174
Shimadzu 17A, 2010 & 2014 GCs 0.5 mm, 10/pk	0.32 mm	211175
Shimadzu 17A, 2010 & 2014 GCs 0.8 mm, 10/pk	0.53 mm	211178



Thermo Instrument Ferrules - M8 Nut	Item No
0.5 mm ID, 10/pk	211905
0.8 mm ID, 10/pk	211908



Thermo Instrument Cup Ferrules - M4 Nut	For Capillary Sizes - ID	Item No
0.28 mm ID, 10/pk	0.10 mm	211982-10
0.38 mm ID, 10/pk	0.25 mm	211983-10
0.48 mm ID, 10/pk	0.32 mm	211984-10
0.80 mm ID, 10/pk	0.53 mm	211988-10

# Ferrules

## GC Inlet Liner Seals; O-rings - Graphite and Fluoroelastomer



For Agilent Instruments	Item No
Graphite Liner Seal, 6.35 mm ID, 10/pk	216635
Graphite Liner Seal, 6.52 mm ID, 10/pk	216652
O-ring made of Fluoroelastomer, 12/pk	216973



For Bruker (Former Varian) Instruments 1078/1079	Item No
Graphite Liner Ferrule, 10/pk	211550



For PerkinElmer Instruments	Item No
Graphite O-Ring, 10/pk	216637



For Shimadzu Instruments	Item No
Graphite Liner Seal, 10/pk	211195
Graphite O-ring, Split, 10/pk	216638
Graphite O-ring, Spiltless, 10/pk	216639



For Thermo Instruments Trace GC	Item No
5 mm Graphite Seal, 2/pk	216949
8 mm Graphite Seal, each	216948



## Vespe<sup>®</sup> Ferrules (SP-1)

Vespe ferrules are made from high temperature Dupont polyimide, a hard polymeric material that tends to seal permanently to capillary columns when in use.



Straight Ferrules - for tubing with ODs listed	Item No
1/16", 10/pk	212100
1/8", 10/pk	212200
1/4", 10/pk	212400



Blank Ferrules - no holes	Item No
1/16", 10/pk	2121XX
1/8", 10/pk	2122XX
1/4", 10/pk	2124XX



Capillary Column Ferrules	For Capillary Sizes - ID	Item No
1/16" to 0.3 mm, 10/pk	0.10 mm	212103
1/16" to 0.4 mm, 10/pk	0.18 - 0.25 mm	212104
1/16" to 0.5 mm, 10/pk	0.32 mm	212105
1/16" to 0.8 mm, 10/pk	0.53 mm	212108
1/16" to 1.0 mm, 10/pk	0.65 mm	212110
1/16" to 1.2 mm, 10/pk	0.75 mm	212112
1/16", two hole 0.4 mm; each	0.25 mm	212124
1/16", two hole 0.5 mm; each	0.32 mm	212125



Short Ferrules for Agilent Inlets*	For Capillary Sizes - ID	Item No
1/16" to 0.4 mm, 10/pk	0.25 mm	212164
1/16" to 0.5 mm, 10/pk	0.32 mm	212165
1/16" to 0.8 mm, 10/pk	0.53 mm	212168

\*Short ferrules for Agilent inlet systems: 5890, 6890 and 7890

# Ferrules



Reducing Ferrules for Capillary Columns	For Capillary Sizes - ID	Item No
1/8" to 0.4 mm, 10/pk	0.25 mm	212204
1/8" to 0.5 mm, 10/pk	0.32 mm	212205
1/8" to 0.8 mm, 10/pk	0.53 mm	212208
1/8", two-hole, 0.5 mm each	0.32 mm	212222



Reducing Ferrules for Tubing	For Tubing Sizes - OD	Item No
1/8" to 1/16", 10/pk	1/16"	212210
1/4" to 1/16", 10/pk	1/16"	212410
1/4" to 1/8", 10/pk	1/8"	212420

Please note general ferrule sizing:

- 0.3 mm ID ferrules fit 0.18 mm ID capillary columns
- 0.4 mm ID ferrules fit 0.25 mm ID capillary columns
- 0.5 mm ID ferrules fit 0.32 mm ID capillary columns
- 0.8 mm ID ferrules fit 0.53 mm ID capillary columns
- Straight ferrules are used for packed columns

## Vespel®/Graphite Ferrules - SP-22 (60% / 40%)

Vespel/Graphite ferrules are made from DuPont polyimide/graphite blended compounds. They are ideal for GC/MS interface applications because they are non-porous to oxygen. They seal with minimal torque and are not re-usable. Due to slight shrinking at high temperatures, they must be retightened after initial temperature cycles to avoid leaks. Two types of Vespel/Graphite are commonly used, one with 40% graphite and one with 15% graphite (page 37).



Straight Ferrules - for tubing with ODs listed	Item No
1/16", 10/pk	213100
1/8", 10/pk	213200
1/4", 10/pk	213400
1/2", 5/pk	213800



Blank Ferrules - no holes	Item No
1/16", 10/pk	2131XX
1/8", 10/pk	2132XX
1/4", 10/pk	2134XX



Capillary Column Ferrules	For Capillary Sizes - ID	Item No
1/16" to 0.3 mm, 10/pk	0.10 mm	213103
1/16" to 0.4 mm, 10/pk	0.18 - 0.25 mm	213104
1/16" to 0.5 mm, 10/pk	0.32 mm	213105
1/16" to 0.8 mm, 10/pk	0.53 mm	213108
1/16" to 1.0 mm, 10/pk	0.65 mm	213110
1/16", two hole 0.4 mm; each	0.25 mm	213124
1/16", two hole 0.5 mm; each	0.32 mm	213125



Short Ferrules for Agilent Inlet*	For Capillary Sizes - ID	Item No
1/16" to 0.3 mm, 10/pk	0.10 - 0.18 mm	213163
1/16" to 0.4 mm, 10/pk	0.25 mm	213164
1/16" to 0.5 mm, 10/pk	0.32 mm	213165
1/16" to 0.8 mm, 10/pk	0.53 mm	213168

\*Short ferrules for Agilent Inlet systems: 5890, 6890 and 7890

# Ferrules



Reducing Ferrules for Capillary Columns	For Capillary Sizes - ID	Item No
1/8" to 0.4 mm, 10/pk	0.25 mm	213204
1/8" to 0.5 mm, 10/pk	0.32 mm	213205
1/8" to 0.8 mm, 10/pk	0.53 mm	213208
1/8", two-holes 0.5 mm, each	0.32 mm	213222
1/8", two-holes 0.8 mm, each	0.53 mm	213228
1/4" to 0.4 mm, 10/pk	0.25 mm	213404
1/4" to 0.5 mm, 10/pk	0.32 mm	213405
1/4" to 0.8 mm, 10/pk	0.53 mm	213408



Reducing Ferrules for Tubing	For Tubing Sizes - OD	Item No
1/8" to 1/16", 10/pk	1/16"	213210
1/4" to 1/16", 10/pk	1/16"	213410
1/4" to 6 mm, 10/pk	6 mm	213406
1/4" to 1/8", 10/pk	1/8"	213420

## Vespel®/Graphite Ferrules - SP-21 (85% / 15%)

Vespel/Graphite ferrules are made from DuPont polyimide/graphite blended compounds. They are ideal for GC/MS interface applications because they are non-porous to oxygen. They seal with minimal torque and are not re-usable. Due to slight shrinking at high temperatures, they must be retightened after initial temperature cycles to avoid leaks. Two types of Vespel/Graphite are commonly used, one with 40% graphite (page 35) and one with 15% graphite.



Straight Ferrules - for tubing with ODs listed	Item No
1/16", 10/pk	215100
1/8", 10/pk	215200
1/4", 10/pk	215400



Blank Ferrules - no holes	Item No
1/16", 10/pk	2151XX
1/8", 10/pk	2152XX
1/4", 10/pk	2154XX



Capillary Column Ferrules	For Capillary Sizes - ID	Item No
1/16" to 0.3 mm, 10/pk	0.10 mm	215103
1/16" to 0.4 mm, 10/pk	0.18 - 0.25 mm	215104
1/16" to 0.5 mm, 10/pk	0.32 mm	215105
1/16" to 0.8 mm, 10/pk	0.53 mm	215108
1/16" to 1.0 mm, 10/pk	0.65 mm	215110
1/16", two hole 0.4 mm; each	0.25 mm	215124
1/16", two hole 0.5 mm; each	0.32 mm	215125



Short Ferrules for Agilent Inlet*	For Capillary Sizes - ID	Item No
1/16" to 0.4 mm, 10/pk	0.10 - 0.25 mm	215164
1/16" to 0.5 mm, 10/pk	0.32 mm	215165
1/16" to 0.8 mm, 10/pk	0.53 mm	215168

\*Short ferrules for Agilent Inlet systems: 5890, 6890 and 7890



# Ferrules



Reducing Ferrules for Capillary Columns	For Capillary Sizes - ID	Item No
1/8" to 0.4 mm, 10/pk	0.25 mm	215204
1/8" to 0.5 mm, 10/pk	0.32 mm	215205
1/8" to 0.8 mm, 10/pk	0.53 mm	215208



Reducing Ferrules for Tubing	For Tubing Sizes - OD	Item No
1/8" to 1/16", 10/pk	1/16"	215210

## PTFE Ferrules

PTFE ferrules are made from 100% PTFE. They are soft and completely inert. PTFE ferrules are commonly used in liquid applications.



Straight Ferrules - for tubing with ODs listed	Item No
1/16", 10/pk	214100
1/8", 10/pk	214200
3/16", 10/pk	214300
1/4", 10/pk	214400



Blank Ferrules - no holes	Item No
1/16", 10/pk	2141XX
1/8", 10/pk	2142XX
1/4", 10/pk	2144XX



Capillary Column Ferrules	For Capillary Sizes - ID	Item No
1/16" to 0.3 mm, 10/pk	0.10 mm	214103
1/16" to 0.4 mm, 10/pk	0.18 - 0.25 mm	214104
1/16" to 0.5 mm, 10/pk	0.32 mm	214105
1/16" to 0.8 mm, 10/pk	0.53 mm	214108
1/16" to 1.0 mm, 10/pk	0.65 mm	214110
1/16" to 1.2 mm, 10/pk	0.75 mm	214112



Reducing Ferrules for Capillary Columns	For Capillary Sizes - ID	Item No
1/8" to 0.4 mm, 10/pk	0.25 mm	214204
1/8" to 0.5 mm, 10/pk	0.32 mm	214205
1/8" to 0.8 mm, 10/pk	0.53 mm	214208



Reducing Ferrules for Tubing	For Tubing Sizes - OD	Item No
1/8" to 1/16", 10/pk	1/16"	214210
1/4" to 6 mm, 10/pk	6 mm	214406
1/4" to 1/16", 10/pk	1/16"	214410
1/4" to 1/8", 10/pk	1/8"	214420
1/4" to 3/16", 10/pk	3/16"	214430



CRS recognizes that food safety is one of the most important industries in analytical chemistry.

Our high-grade, low-extractable products are widely used and trusted by food safety labs.



# GC Septa

Premium Septa . . . . .	42-45
BTO <sup>®</sup> . . . . .	43
AG3 <sup>™</sup> . . . . .	44
Marathon <sup>™</sup> . . . . .	45
General Purpose Septa . . . . .	46-47
Economy Blue . . . . .	46
Puresep T <sup>™</sup> . . . . .	46
Puresep P <sup>™</sup> . . . . .	47

## Premium Septa

Premium Septa are preconditioned for low bleed, plasma-coated to reduce sticking and are packed in glass jars for high purity. Premium septa are precision molded to ensure an accurate fit.

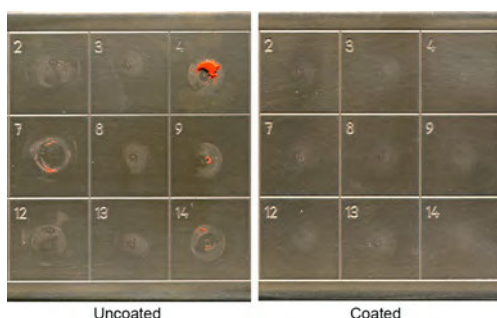
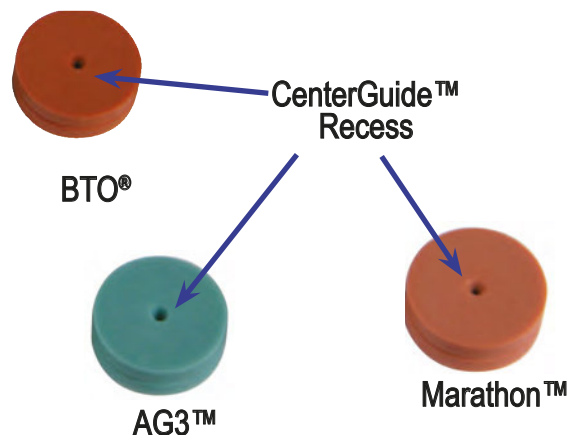

### High Temperature Performance

Accelerated high-temperature tests show adhesion of silicone rubber formulations to a steel plate, with and without the CRS Non-stick coating. The difference in adhesion is readily apparent. In actual use this performance means easier septum removal and less injection port cleanup.

Exposed to Dust		Cleaned with Air	
Uncoated	Coated	Uncoated	Coated

### Plasma Coating

- Non-stick surface treatment
- Easy to change, even after high-temperature use
- Stays clean, does not attract dust

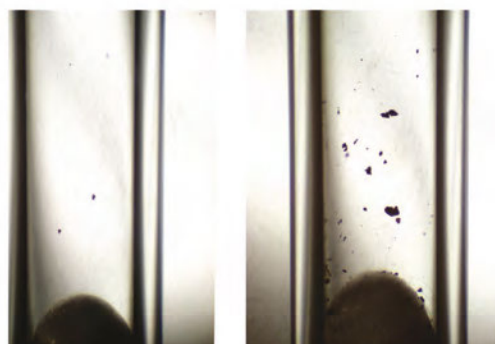

Centerguide™ and pre-pierced

Non-Centerguide™ and non-pierced

### CenterGuide™ & Pre-pierced Advantage

- Center point guides the needle for easy penetration
- Reduces needle bending
- Reduces coring and tearing

Premium septa are precision-molded with a recess on the injection side, to guide the syringe needle to the same point with every injection. The CenterGuide™ design requires less force on initial penetration for a smoother feel. Pre-pierced septa give long injection life for autosampling, reduce coring, and enhance reliable performance.





## Septa BTO®

Septa BTO is *Bleed and Temperature Optimized* for today's most demanding GC and GC/MS applications. Septa BTO is formulated to extend low-bleed and outstanding mechanical properties of premium GC septa to the highest-temperature applications. It retains remarkable softness and pierceability at high temperatures, with extremely low bleed. Septa BTO are packaged in glass jars for high purity. CenterGuide™ on select sizes are listed.



Description	Qty	Item No.
5 mm CenterGuide™	50/pk	298787
6 mm (1/4")	50/pk	298755
9 mm CenterGuide	50/pk	298713
9.5 mm (3/8")	50/pk	298705
10 mm	50/pk	298745
11 mm (7/16") CenterGuide	50/pk	298717
11 mm (7/16") CenterGuide	100/pk	298718
11.5 mm CenterGuide	50/pk	298777
12.7 mm (1/2") CenterGuide	50/pk	298727
17 mm CenterGuide	50/pk	298817
Shimadzu	50/pk	298735

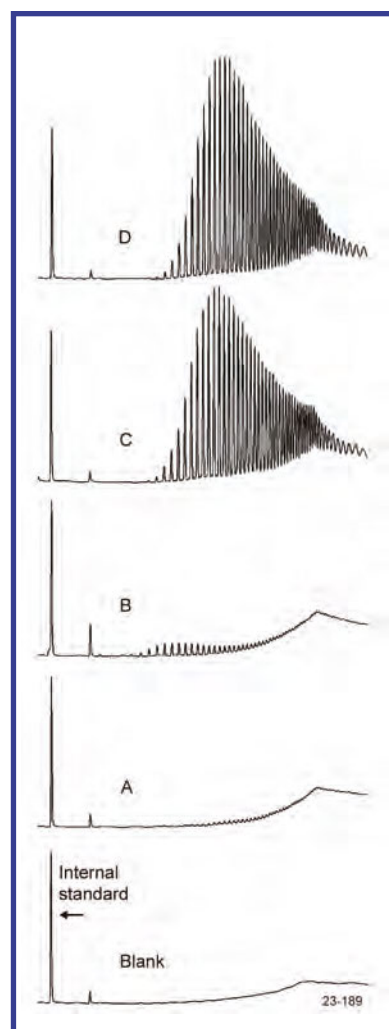
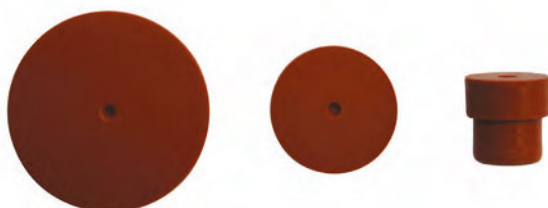

Septa BTO has the lowest bleed of any septa we have tested. Solvent extracts of residual silicones:

- A) BTO®
- B) AG3™
- C) Competitor's high-temp red septa
- D) Competitor's low-bleed green septa

## Premium Septa



### Advanced Green 3™

The CRS Advanced Green 3 Septum was specifically created to combine significantly longer injection life, low bleed and low injection port adhesion. The result is a green septum that can be used for all critical analyses. Advanced Green 3 Septa are packaged in glass jars for high purity. CenterGuide™ on select sizes are listed.



Description	Qty	Item No.
5 mm CenterGuide	50/pk	246525
9 mm CenterGuide	50/pk	246713
9.5 mm (3/8")	50/pk	246124
11 mm (7/16") CenterGuide	50/pk	246225
11 mm (7/16") CenterGuide	100/pk	246228
11.5 mm CenterGuide	50/pk	246725
12.7 mm (1/2") CenterGuide	50/pk	246325
17 mm CenterGuide	50/pk	246624
Shimadzu	50/pk	246424

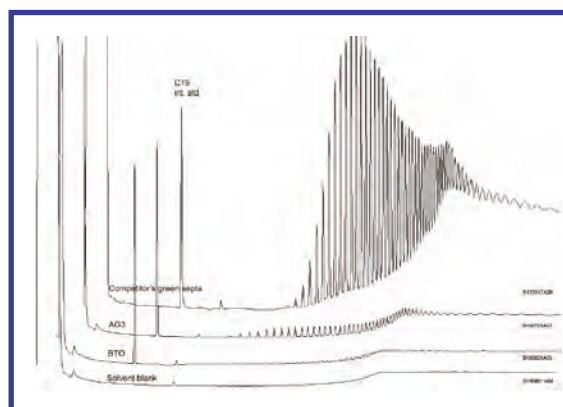

Top to Bottom:  
 Competitor's low-bleed green septa  
 AG3™  
 BTO®  
 Blank

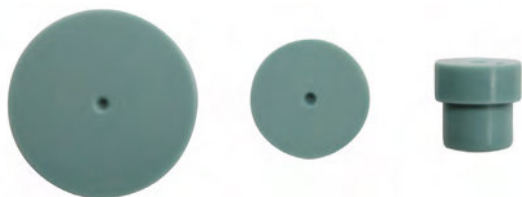



## Marathon™

Marathon are pre-pierced to channel the needle through the same spot with each injection, which helps eliminate the common type of coring that may occur on the first injection. The Marathon septum is also ideal for standard manual-injection GC and GC/MS. Marathon Septa are packaged in glass jars for high purity. CenterGuide™ on select sizes are listed.



Description	25/pk	50/pk	100/pk
5 mm CenterGuide	239587	239597	
9 mm CenterGuide	239778	239779	
11 mm (7/16") CenterGuide	239287	239297	239888
11.5 mm CenterGuide	239787	239798	
12.7 mm (1/2") CenterGuide	239387	239397	
17 mm CenterGuide	239688	239698	
Shimadzu	239488	239498	

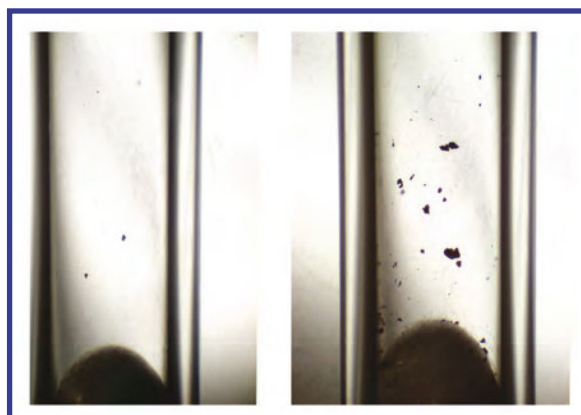

Our Marathon Septa are pre-pierced to enhance septa life and performance in some applications by minimizing tearing and coring often found when general purpose septa are used. Left: CenterGuide™ and pre-pierced. Right: Non-CenterGuide™ and non-pierced.

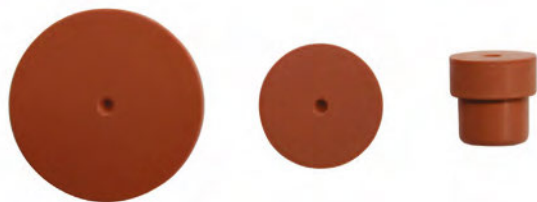

## General Purpose Septa



### Economy Blue Septa

CRS Blue Septa are designed for routine applications. They are made from silicone and easy to penetrate.

Description	50/pk	100/pk
5 mm	234106	234105
6 mm (1/4")	234626	234625
9 mm	234108	234109
9.5 mm (3/8")	234906	234905
10 mm	234111	234110
11 mm (7/16")	234116	234115
11.5 mm	234216	234215
12.7 mm (1/2")	234126	234125
17 mm	234118	234117
Shimadzu	234121	234120



### Puresep T™

A silicone-based septum, faced on one side with a double layer of polyimide and PTFE. The polyimide adheres to both the silicone and PTFE, providing a better bond and enhanced durability. The outer PTFE coating assures maximum inertness and helps minimize bleed.

Description	Qty	Item No.
6 mm (1/4")	50/pk	230665
9.5 mm (3/8")	50/pk	230675
11 mm (7/16")	50/pk	230685
11.5 mm	50/pk	230697
12.7 mm (1/2")	50/pk	230695



**BLOGables**

Are you choosing the right Septa? Find out online at <https://www.ChromRes.com/blog/>

Useful and relevant discussions related to the GC industry including product information, troubleshooting, FAQ, and recommendations from our skilled experts.



## Puresep P™

Puresep P™ is made from silicone coated with a layer of high temperature polyimide.

Description	Qty	Item No.
6 mm (1/4")	50/pk	230630
9.5 mm (3/8")	50/pk	230640
11 mm (7/16")	50/pk	230650
11.5 mm	50/pk	230670
12.7 mm (1/2")	50/pk	230660



### Do you know about our Premium Septa?

Learn how our premium septa can make a difference in your analysis on page 42.



BTO®



AG3™



Marathon™

## Measuring Chart

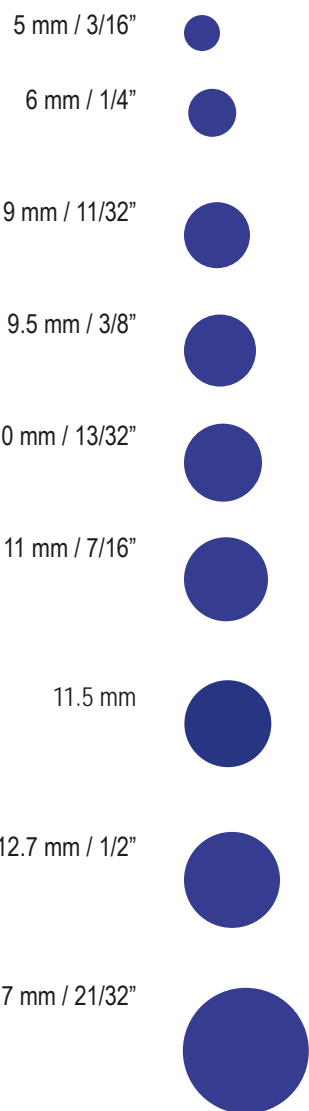





Are strict procedures and uncontaminated components important to you? Us too!

Know exactly what you are getting with high-grade CRS products for your analytical needs.





# Crimping Tools

Manual Crimping Tools . . . . .	50
Electronic Crimping Tools . . . . .	51
High Power Crimping Tools . . . . .	52-53
Accessories . . . . .	54

# Crimping Tools

## Manual Crimpers and Decappers

- Easily-viewed adjustment knob
- Strong light-weight plastic body
- Bottom-pull handle design prevents wobbling
- Curved high-strength plastic handles
- Available for flip-off caps in 13 mm and 20 mm sizes (not for use with *flip-up* caps)
- Optional crimper stand available (page 54)



### Adjusting the Crimp Setting

The adjustment knob is conveniently positioned at the head of the crimper and clearly displays + and - symbols along with directional arrows. This simplifies adjusting the intensity of the crimp to the desired setting. When the knob touches the crimper body, the crimp setting has been reached. No more “extra squeeze” necessary! Available in 8 mm (crimper only), 11 mm, 13 mm, and 20 mm cap sizes; including the flip-off style in 13 mm and 20 mm cap sizes.

Description	Item No.
8 mm Crimper	308990
11 mm Crimper	311990
13 mm Crimper	313990
13 mm Crimper for Flip Off Caps*	313992
20 mm Crimper	320990
20 mm Crimper for Flip Off Caps*	320992
*Not for use with Flip-Up Caps	
11 mm Decapper	311991
13 mm Decapper	313991
20 mm Decapper	320991

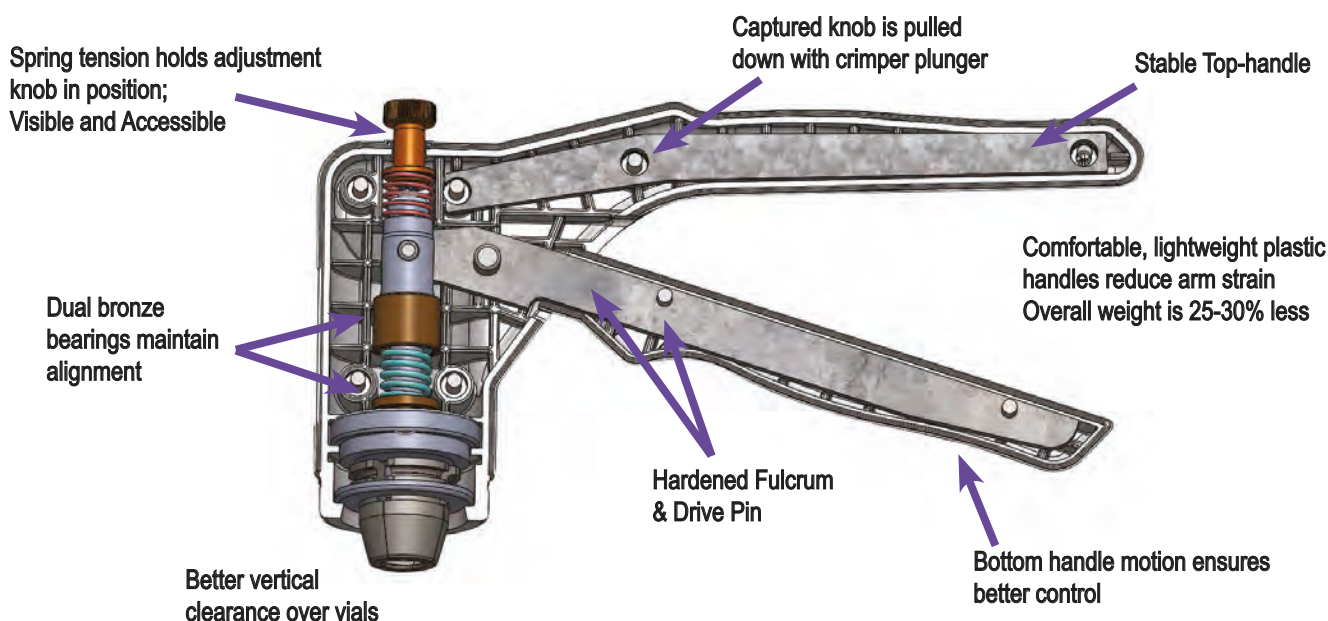

# Electronic Crimpers and Decappers

- Powerful motor allows fast cycles
- Long lasting battery with Lithium Ion technology
- Advanced charging system includes warning light when recharging is necessary
- Can be operated while charging
- Convenient controls on top of unit to adjust power
- Not for use with all steel/magnetic caps, see High Power Crimper (page 52)
- Available for flip-off caps in 13 mm and 20 mm sizes (not for use with *flip-up* caps)
- Optional base with mounting kit and stand (page 54)

CRS electronic crimpers and decappers fit standard laboratory vials and seals with aluminum or two-part aluminum/steel caps. For all steel caps see the High Power Crimper on page 52. The crimper jaws easily fit around vials that are set in standard autosampler trays. The electronically-adjustable cycle is accurate and reproducible and can be adjusted with the control pad on top of the unit.

The tools are ergonomically designed to reduce strain and arm injury associated with many manual crimping tools. Available in 8 mm (crimper only), 11 mm, 13 mm, and 20 mm cap sizes; including the flip-off style in 13 mm and 20 mm cap sizes.

## Rechargeable

The tools can be recharged in one to two hours with the universal power supply included. The power supply includes a plug set for operation in most countries.



Description	Item No.
8 mm Crimper	5A08C0
11 mm Crimper	5A11C0
13 mm Crimper	5A13C0
13 mm Crimper for Flip Off Caps*	5A13F0
20 mm Crimper	5A20C0
20 mm Crimper for Flip Off Caps*	5A20F0
*Not for use with Flip-Up Caps	
11 mm Decapper	5A11D0
13 mm Decapper	5A13D0
20 mm Decapper	5A20D0

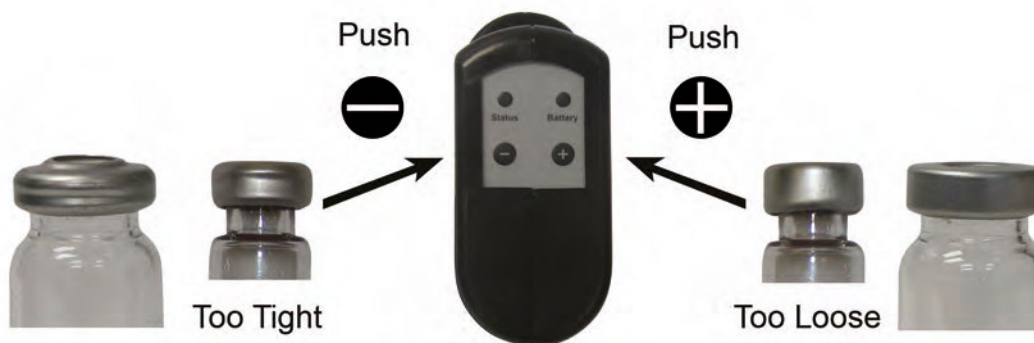

## High Power Crimping Tool

- Fastest and most powerful CRS crimping Tool
- Strong enough for all steel and magnetic caps
- Designed with external power source and cord (no battery)
- Uses interchangeable jaw sets (ordered separately)
- Stores separate programs for different caps and seals
- Jaws available for flip-off caps in 13 mm and 20 mm sizes (not for use with *flip-up* caps)
- Optional base and mounting kit (see page 54)



The CRS High Power Crimper is designed with interchangeable jaws so that you only need one crimping tool. You can then choose which size crimper and decapper jaw sets fit your laboratory needs. The jaw sets fit standard laboratory vials with aluminum, two-part aluminum/steel, and all-steel crimp caps. This crimping tool has the ability to store separate programs for different style caps and cap sizes. The tools are ergonomically designed to reduce strain and arm injury associated with many manual crimping tools. Jaw sets are available in 8 mm (crimper only), 11 mm, 13 mm, and 20 mm cap sizes, including flip-off style in 13 mm and 20 mm cap sizes.

Description	Item No.
High Power Electronic Crimping Tool	5AHPS0
8 mm Crimper Jaw	308955
11 mm Crimper Jaw	311955
13 mm Crimper Jaw	313955
13 mm Crimper Jaw for Flip Off Caps*	313956
20 mm Crimper Jaw	320955
20 mm Crimper Jaw for Flip Off Caps*	320956
*Not for use with Flip-Up Caps	
11 mm Decapper Jaw	311965
13 mm Decapper Jaw	313965
20 mm Decapper Jaw	320965

### Switching Jaw Sets

Jaw sets are easy to interchange. Simply insert the jaw set into the bushing at the bottom of the tool. Push up and twist until the set locks into position. To remove, push the outside button and rotate.





# High Power Crimping Tool with External Control

- Programmable version of the High Power crimping tool with a fixed power supply and cord (no battery)
- Serial RS485 connection allows for external control of all the crimper's functions with a programmable controller or PC
- Demonstration software for interface included
- Uses interchangeable jaw sets
- Stores separate programs for different caps and seals
- Strong enough for all steel and magnetic caps
- Jaws available for flip-off caps in 13 mm and 20 mm sizes (not for use with *flip-up* caps)
- Optional base and mounting kit (see page 54)



Description	Item No.
High Power Electronic Crimping Tool External Control	5AHPR0

For full listing of available jaw sets, please see page 52.

The CRS High Power Crimper is designed with interchangeable jaws so that you only need one crimping tool. You can then choose which size crimper and decapper jaw sets fit your laboratory needs. The jaw sets fit standard laboratory vials with aluminum, two-part aluminum/steel, and all-steel crimp caps. This crimping tool has the ability to store separate programs for different style caps and cap sizes. The tools are ergonomically designed to reduce strain and arm injury associated with many manual crimping tools. Jaw sets are available in 8 mm (crimper only), 11 mm, 13 mm, and 20 mm cap sizes, including flip-off style in 13 mm and 20 mm cap sizes. The programmable version allows for external control of crimper functions with a remote or PC. Interface demonstration software is included.



5AHPR0 uses the same jaw sets as the high power crimping tool. See listing on page 52.



**BLOGables**

Why Should you be using an Electronic Crimper? Find out online at <https://www.ChromRes.com/blog/>

Useful and relevant discussions related to the GC industry including product information, troubleshooting, FAQ, and recommendations from our skilled experts.



# Crimping Tools

## Crimping Tool Accessories



### Base and Mounting Kit

The Base and Mounting Kit is available for use with either the Electronic Crimping Tools or with High Power Electronic Crimping Tools. The kit is easy to assemble and all hardware is included.

Description	Item No.
Base and Mounting Kit	5ABAS0



### Crimping Tool Stand

The Crimping Tool Stand is available for use with both the Electronic and Manual Crimping Tools.

Description	Item No.
Crimper Stand	5ASTA0



### Replacement Battery

Longer lasting battery with Lithium Ion technology.

Description	Item No.
6.6 Volt Lithium Ion Battery	HPB6-A



### DJ's Fun Fact

CRS was first to manufacture and patent the electronic crimper in 1999.



## Vials, Caps and Seals

12 x 32 mm Crimp Top . . . . .	58-61
Standard Mouth . . . . .	58
Wide Mouth . . . . .	60
12 x 32 mm Screw Top . . . . .	62-65
Standard Mouth . . . . .	62
Wide Mouth . . . . .	65
Vial Inserts . . . . .	66
9 mm Screw Top . . . . .	67
HPLC Vials . . . . .	68
Miscellaneous Vials . . . . .	69-70
15 x 45 mm Screw Top . . . . .	71-73
Sample Vials . . . . .	74
Headspace Crimp Top . . . . .	75-77
Headspace Screw Top . . . . .	78
EPA Sampling Vials . . . . .	79-81
Caps and Seals . . . . .	82-86
Accessories . . . . .	87

# Vials, Caps and Seals

## 12 x 32 mm Standard Mouth



## 12 x 32 mm Wide Mouth

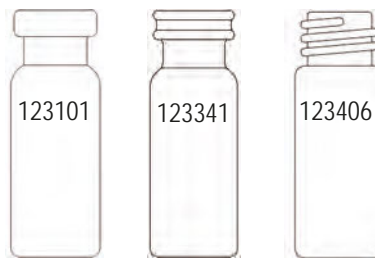

## Standard Mouth Vial Inserts

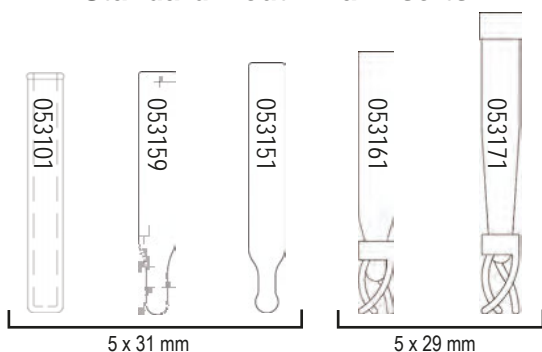

## Wide Mouth Vial Inserts

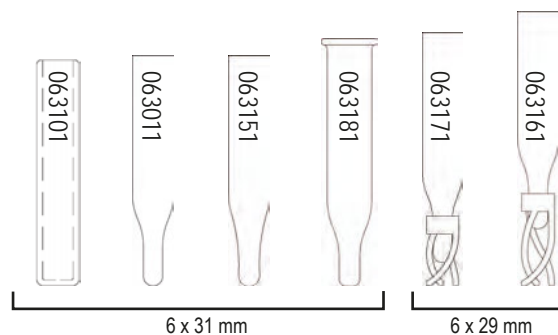

## 15 x 45 mm Vials and Inserts

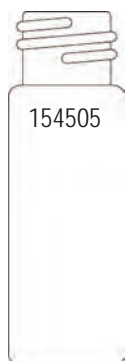

## Misc. Vials



## Conical / Limited Volume Vials

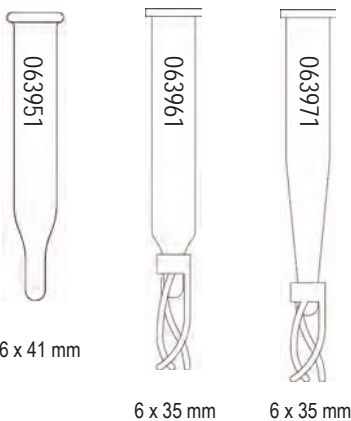
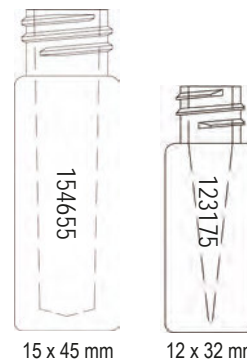

## Sample Vials

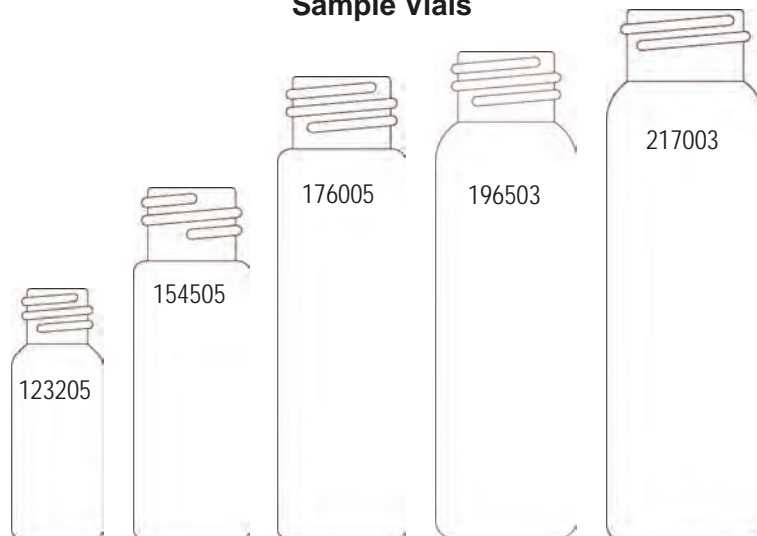

### EPA Vials



### Shell Vials

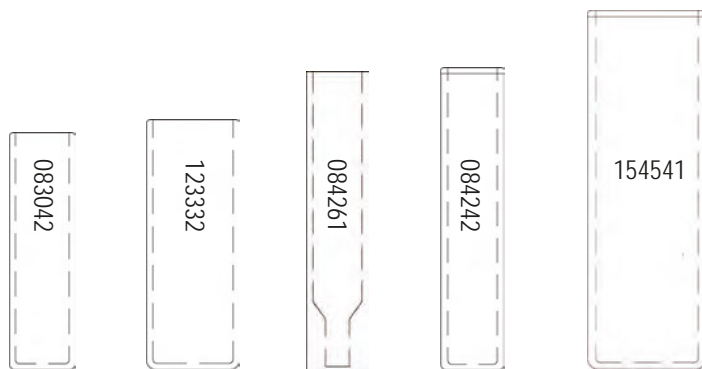

### Reaction Vials

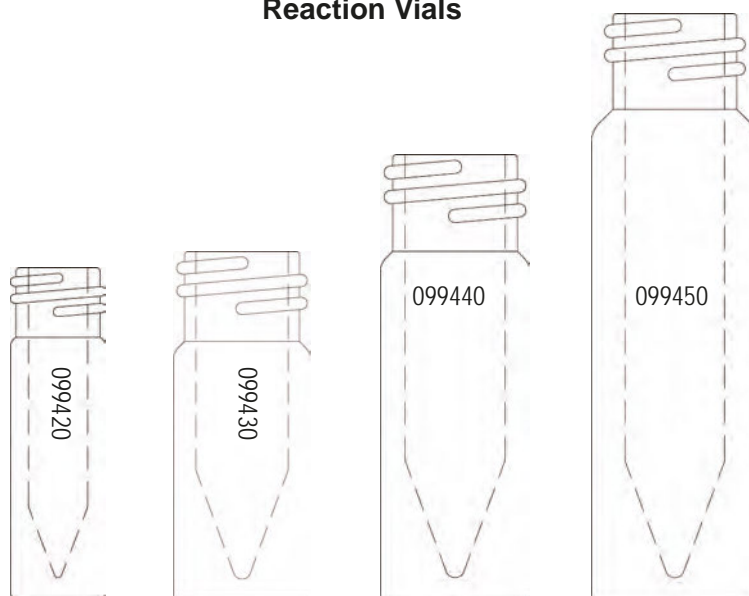

### Headspace Vials

#### Beveled Top Flat Bottom

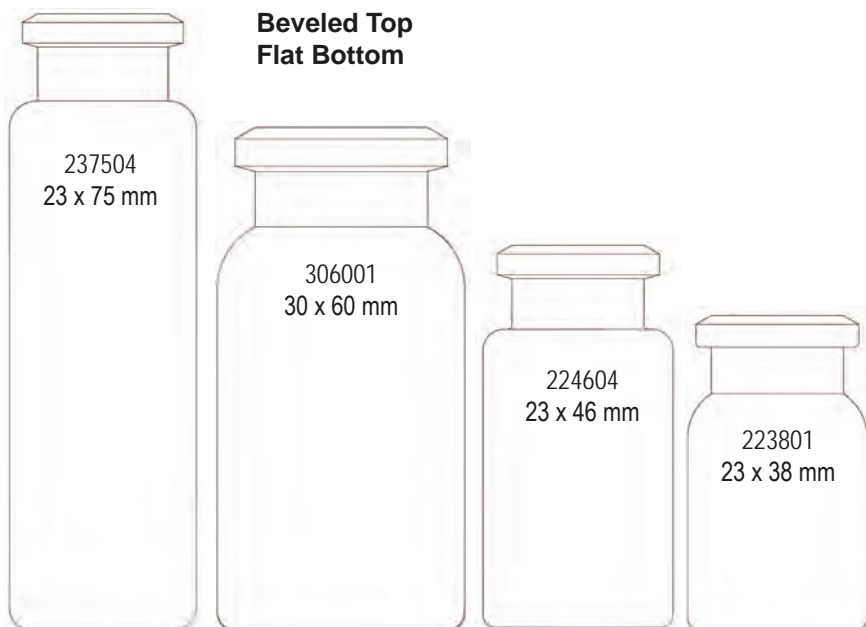

#### Beveled Top Round Bottom

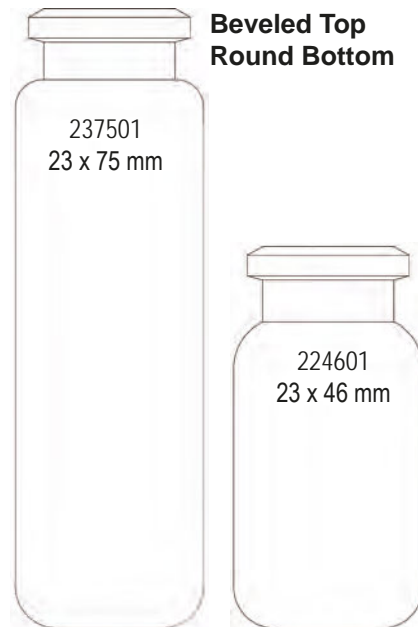

# Vials, Caps and Seals

## 12 x 32 mm Crimp, Standard Mouth



### 1.8 mL Crimp Top Vials

- Compatible with most GC and HPLC autosamplers using 12 x 32 mm (1.8 mL) vials
- All vials are made from type 1 borosilicate glass
- Uses caps and seals listed on page 59

Description	Qty	Item No.
1.8 mL Clear Crimp Vial	100/pk	123201
1.8 mL Amber Crimp Vial	100/pk	123211
1.8 mL Clear Graduated Crimp Vial	100/pk	123202
1.8 mL Amber Graduated Crimp Vial	100/pk	123203



### Combo Pack

Description	Qty	Item No.
1.8 mL Clear Vial, Cap, Std. Seal	100/pk	123221
1.8 mL Clear Graduated Vial, Cap, Std. Seal	100/pk	123491



### Inserts

- Allows use of microliter-size samples
- Fits inside standard-mouth 12 x 32 mm, 1.8 mL vials
- Mandrel-Point or Punched-Point tip available
- Inserts measure 5 x 31 mm except TriSpring inserts, 5 x 29 mm
- TriSpring inserts have a plastic spring already attached, to center the insert and absorb shocks to minimize needle damage
- Type 1 borosilicate glass except as noted

Description	Qty	Item No.
250 µL Flat-Bottom Insert	100/pk	053101
100 µL Punched-Point Insert	100/pk	053159
100 µL Mandrel-Point Insert	100/pk	053151
100 µL TriSpring Insert	100/pk	053161
100 µL TriSpring Insert, Polypropylene	100/pk	053171

Shown above left to right in order listed.



## 11 mm Crimp Caps and Seals for 1.8 mL Vials

- Caps are made from lacquered aluminum and have an open-hole design
- Pre-stuffed with seals listed below

**Standard Seal** - Good for routine use; self-sealing.

**Seal S** - A better-quality PTFE/silicone seal.

**Seal TT** - Premium-grade seal with two layers of PTFE. Coring is virtually eliminated.

**TruSeal™** - A Silicone/PTFE seal offers lower permeability and bleed than natural rubber, and resists degradation to 250°C. Because the TruSeal is soft, lower crimping force is recommended.

Description	Material	Qty	Item No.
Silver Cap, Std. Seal	PTFE/Rubber	100/pk	311001
Blue Cap, Std. Seal	PTFE/Rubber	100/pk	311001B
Green Cap, Std. Seal	PTFE/Rubber	100/pk	311001G
Gold Cap, Std. Seal	PTFE/Rubber	100/pk	311001GO
Orange Cap, Std. Seal	PTFE/Rubber	100/pk	311001O
Purple Cap, Std. Seal	PTFE/Rubber	100/pk	311001PU
Red Cap, Std. Seal	PTFE/Rubber	100/pk	311001R
Yellow Cap, Std. Seal	PTFE/Rubber	100/pk	311001Y
Steel Cap	No Seal	100/pk	311002
Silver Cap and Seal S	PTFE/Sil.	100/pk	311201
Silver Cap and Seal TT	PTFE/Sil./PTFE	100/pk	311401
Silver Cap and TruSeal	PTFE/Silicone	100/pk	311231



### DJ Recommends:

Reduce wrist strain with an electronic crimper from CRS!  
Read more on **page 51**.



# Vials, Caps and Seals

## 12 x 32 mm Crimp, Wide Mouth



### 1.8 mL Wide Crimp Top Vials

- Wider opening minimizes bent autosampler needles, especially when using inserts
- All vials are made from type 1 borosilicate glass

Caps and Seals - Wide-mouth vials use the same caps and seals as CRS standard mouth vials listed on page 59.

Description	Qty	Item No.
1.8 mL Clear Wide Crimp Vial	100/pk	123101
1.8 mL Amber Wide Crimp Vial	100/pk	123211A
1.8 mL Clear Graduated Wide Crimp Vial	100/pk	123222
1.8 mL Amber Graduated Wide Crimp Vial	100/pk	123224



### Combo Pack

Description	Qty	Item No.
1.8 mL Clear Wide Vial, Cap, Std. Seal	100/pk	123121
1.8 mL Amber Wide Graduated Vial, Cap, Std. Seal	100/pk	123236



### Inserts

- Allows use of microliter-size samples
- Fit inside wide-mouth 12 x 32 mm, 1.8 mL vials
- Mandrel-Point or Pulled-Point tip available
- Inserts measure 6 x 31 mm except TriSpring inserts, 6 x 29 mm
- TriSpring inserts have a plastic spring already attached, to center the insert and absorb shocks to minimize needle damage
- Type 1 borosilicate glass except as noted

Description	Qty	Item No.
350 $\mu$ L Flat-Bottom Insert	100/pk	063101
250 $\mu$ L Pulled-Point Insert	100/pk	063011
250 $\mu$ L Mandrel-Point Insert	100/pk	063151
250 $\mu$ L TriSpring Insert	100/pk	063161
250 $\mu$ L TriSpring Insert, Polypropylene	100/pk	063171
250 $\mu$ L Tapered Hanging Insert	100/pk	063181

*Shown above left to right in order listed.*



## 1.8 mL Snap/Crimp Wide Mouth Vials

- Uses caps for Snap/Crimp Vials listed below
- Easy to use
- Type 1 borosilicate glass vials
- Polyethylene caps available with a variety of septum materials

Description	Qty	Item No.
1.8 mL Snap/Crimp Clear Vial	100/pk	123341
1.8 mL Snap/Crimp Amber Vial	100/pk	123343
1.8 mL Snap/Crimp Clear Graduated Vial	100/pk	123371
1.8 mL Snap/Crimp Clear Label Vial with 250 µL Insert	100/pk	123344



Description	Seal Material	Qty	Item No.
Snap Cap	PTFE	100/pk	311251
Snap Cap	PTFE/Rubber	100/pk	311261
Snap Cap	PTFE/Silicone	100/pk	311271
Snap Cap	Polyethylene	100/pk	311281



## 0.25 mL Pre-Inserted Crimp Vial

- Vials have a permanently-attached insert
- Unique one-piece design easier for microsampling
- Recommended for Agilent 7673 A/B; 7683 A/B
- Type 1 borosilicate glass vials

Caps and Seals - Wide-mouth vials use the same caps and seals as CRS standard mouth vials listed on page 59.

Description	Qty	Item No.
Pre-Inserted Clear Vial	100/pk	123281
Pre-Inserted Clear Vial with Label	100/pk	123284
Pre-Inserted Amber Vial with Label	100/pk	123286



### DJ's Tech Tips

Turn to **page 50** to learn about the benefits of our manual and electronic crimping tools.

# Vials, Caps and Seals

## 12 x 32 mm Screw, Standard Mouth



### 1.8 mL Screw Top Vials

- Compatible with most GC and HPLC autosamplers requiring 1.8 mL, 12 x 32 mm vials (12 x 35 mm with cap)
- Vials use 8 mm, 8-425 caps
- Combo packs include vial and pre-stuffed cap with PTFE/Silicone seal
- Label vials can be marked with an ordinary pen or pencil on permanent ceramic patch
- Graduated label vials show the approximate volume of contents
- Type 1 borosilicate glass vials

Description	Qty	Item No.
1.8 mL Clear Screw Vial	100/pk	123205
1.8 mL Amber Screw Vial	100/pk	123215
1.8 mL Clear Label Screw Vial	100/pk	123315
1.8 mL Clear Graduated Screw Vial	100/pk	123340
1.8 mL Amber Graduated Screw Vial	100/pk	123342



### Combo Pack

Description	Qty	Item No.
Clear Vial, Cap, PTFE/Silicone Seal	100/pk	123225
Amber Vial, Cap, PTFE/Silicone Seal	100/pk	123135
Clear Grad. Vial, Cap, PTFE/Silicone Seal	100/pk	123385



### Inserts

- Allows use of microliter-size samples
- Fit inside standard-mouth 12 x 32 mm, 1.8 mL vials
- Mandrel-Point or Pulled-Point tip available
- Inserts measure 5 x 31 mm except TriSpring inserts, 5 x 29 mm
- TriSpring inserts have a plastic spring already attached, to center the insert and absorb shocks to minimize needle damage
- Type 1 borosilicate glass except as noted

Description	Qty	Item No.
250 µL Flat-Bottom Insert	100/pk	053101
100 µL Pulled-Point Insert	100/pk	053159
100 µL Mandrel-Point Insert	100/pk	053151
100 µL TriSpring Insert	100/pk	053161
100 µL TriSpring Insert, Polypropylene	100/pk	053171

*Shown above left to right in order listed.*



### Do you know about our Quick Order option?

With our online Quick Order module, you can add multiple part numbers to your cart in seconds! Great for frequent large ordering!



## 8 mm Caps and Seals

- Caps have open hole design; 8-425 threads
  - Available individually or pre-stuffed with seals to save time and effort
  - Pierceable screw caps are for single-time use. They have a polypropylene seal molded into the cap, so it cannot fall out
- \*Note:** Shimadzu, Hitachi and Jasco autosamplers require a special wide-lip cap, listed at right, or use wide mouth vials with these autosamplers.

**Standard Seal** - Good for routine use; self-sealing.

**Silicone Seal ST** - Made from white silicone rubber faced with a PTFE layer.

**Seal TT** - Premium-grade seal with two layers of PTFE. Coring is virtually eliminated.

**TruSeal™** - A Silicone/PTFE seal offers lower permeability and bleed than natural rubber, and resists degradation to 250°C. Because the TruSeal is soft, lower crimping force is recommended.

**Slit Seal** - Recommended for Hitachi, Jasco and Shimadzu autosamplers. Prescored for easy needle penetration. Use with standard mouth vials and wide lip caps.

### Caps

Description	Material	Qty	Item No.
Standard Screw Cap	Black Polypropylene	100/pk	308115
Wide-Lip Screw Cap*	Black Polypropylene	100/pk	309115
Wide-Lip Screw Cap*	White Polypropylene	100/pk	309415



### Seals

Description	Material	Qty	Item No.
Silicone Seal ST	PTFE/Silicone	100/pk	308515
Seal TT	PTFE/Silicone/PTFE	100/pk	308715
Slit Seal	PTFE/Silicone	100/pk	309715
TruSeal	PTFE/Silicone	100/pk	308565



### Pre-Assembled Open-Hole Screw Caps

Description	Material	Qty	Item No.
Cap with Seal ST	PP/PTFE/Silicone	100/pk	309525
Cap with Seal TT	PP/PTFE/Sil./PTFE	100/pk	309585

# Vials, Caps and Seals

## 12 x 32 mm Screw, Standard Mouth



### 1.8 mL Pre-Assembled Screw Top Vials

- Completely pre-assembled with PTFE/Silicone seal and open-hole screw cap
- Type 1 borosilicate glass
- Cap is made from polypropylene

**Silicone Seal ST** - Made from white silicone rubber faced with a PTFE layer.

**Seal TT** - Premium-grade seal with two layers of PTFE. Coring is virtually eliminated.

Description	Qty	Item No.
1.8 mL Pre-assembled Vial ST Seal	100/pk	123425
1.8 mL Pre-assembled Vial TT Seal	100/pk	123435



### 0.1 mL Conical Vials

- Standard dimensions of 12 x 32 mm, yet 100 µL capacity for small sample sizes
- Standard mouth design with 8-425 threads
- Use standard 8-425 thread screw caps and seals listed on page 63
- Polypropylene is translucent white in color
- TPX (polymethylpentene) has properties similar to polypropylene, but with transparency close to that of glass

Description	Qty	Item No.
0.1 mL Poly Screw Top Vial	100/pk	123165
0.1 mL TPX Screw Top Vial	100/pk	123175



### 1.1 mL Tapered Bottom Vial\*

- Microsampling and analysis with one vial
- Tapered bottom lets you concentrate samples into the tip by solvent evaporation
- Standard mouth design; 8-425 threads
- Type 1 borosilicate glass

Description	Qty	Item No.
1.1 mL Tapered Bottom Vial	100/pk	123255

\* 5 pack minimum order



### Did you know?

You can register online at [www.ChromRes.com](http://www.ChromRes.com) for order history, tracking numbers, and to pay your invoices from your dashboard!



# 12 x 32 mm Screw, Wide Mouth



## 1.8 mL Screw Top Vials

- 40% larger opening than our standard vial
- Minimizes risk of bent needles; especially when using small volume inserts
- Compatible with most GC/HPLC autosamplers requiring 1.8 mL, 12 x 32 mm vials
- Type 1 borosilicate glass
- Uses 10-425 thread caps and seals listed at right

Description	Qty	Item No.
1.8 mL Clear Wide Screw Vial	100/pk	123405
1.8 mL Amber Wide Screw Vial	100/pk	123406
1.8 mL Clear Graduated Wide Screw Vial	100/pk	123408
1.8 mL Amber Graduated Wide Screw Vial	100/pk	123409



## Combo Pack

Description	Qty	Item No.
1.8 mL Wide Vial, Cap, PTFE/Silicone	100/pk	123415



## 10 mm Cap and 9 mm Seals

- 10 mm, 10-425 thread caps fits the thread dimensions of 1.8 mL wide mouth vials
- Made from polypropylene; open-hole design
- Wide mouth vials are recommended for use with autosamplers that require vials to be suspended by the cap, including Shimadzu, Hitachi and Jasco (not recommended for the Agilent 7673 or 7683 A/B)
- Caps use 9 mm seals

**Silicone Seal ST** - Made from white silicone rubber faced with a PTFE layer.

**Seal TT** - Premium-grade seal with two layers of PTFE. Coring is virtually eliminated.

**Seal PTFE** - Disk is pure PTFE; not resealable.

**Slit Seal** - Recommended for Hitachi, Jasco and Shimadzu autosamplers. Pre-scored for easy needle penetration. Use with standard mouth vials and wide lip caps.

### Cap

Description	Material	Qty	Item No.
10 mm Black Cap	Polypropylene	100/pk	310115

### Seals

Description	Material	Qty	Item No.
9 mm Silicone Seal ST	PTFE/Silicone	100/pk	310515
9 mm Seal TT	PTFE/Sil./PTFE	100/pk	310615
9 mm Seal PTFE	PTFE	100/pk	310005
9 mm Slit Seal	PTFE/Silicone	100/pk	310815

- For use when you only have a small amount of sample available for analysis



## Inserts for 12 x 32 mm Vials

- Available in a variety of styles, to fit both standard and wide mouth 1.8 mL, 12 x 32 mm vials
- Inserts for standard mouth vials measure 5 x 31 mm except TriSpring inserts which are 5 x 29 mm
- Inserts for wide mouth vials measure 6 x 31 mm except TriSpring inserts which are 6 x 29 mm

**Flat Bottom Inserts** - have the largest capacity. They are placed directly in the host vial.

**Tapered Bottom Inserts** - allow sampling of just microliters of liquid, with nearly complete withdrawal from the tip. They are also set directly into the host vial. The tips are either drawn during manufacture ("pulled point") or formed ("mandrel point").

**TriSpring Inserts** - have a plastic spring already attached to the tapered bottom. The spring centers the insert in the host vial and acts as a shock absorber if the insert is touched by the autosampler needle.

**Hanging Insert** - has a lip that rests on top of a wide mouth crimp or screw vial. The septum seals directly and positively against the insert, reducing the risk of solvent evaporation. Available for wide-mouth vials only.



Description	Qty	Item No.
<b>Inserts for Standard Mouth 1.8 mL Vials, Type 1 Borosilicate Glass</b>		
250 µL Flat Bottom Insert	100/pk	053101
100 µL Pulled Point Insert	100/pk	053159
100 µL Mandrel Point Insert	100/pk	053151
100 µL TriSpring Insert	100/pk	053161

<b>Inserts for Standard Mouth 1.8 mL Vials, Polypropylene</b>		
100 µL TriSpring Insert	100/pk	053171

*Shown above left to right in order listed.*



<b>Inserts for Wide Mouth 1.8 mL Vials, Type 1 Borosilicate Glass</b>		
350 µL Flat Bottom Insert	100/pk	063101
250 µL Pulled Point Insert	100/pk	063011
250 µL Mandrel Point Insert	100/pk	063151
250 µL TriSpring Insert	100/pk	063161
250 µL Tapered Hanging Insert	100/pk	063181

<b>Inserts for Wide Mouth 1.8 mL Vials, Polypropylene</b>		
250 µL TriSpring Insert, Polypropylene	100/pk	063171

*Shown above left to right in order listed.*

### Tapered Inserts Mandrel-Point vs. Pulled-Point

Tapered glass inserts are manufactured in different ways. The point can either be flame-drawn and pulled (pulled point) or shaped over a die (mandrel point). The pulled point is less costly to produce, while the mandrel point typically has more accurate dimensional tolerances.



# 9 mm Screw Thread Vials



## 1.8 mL Screw Thread Vials

- Large-opening vials
- 9 mm finish
- For use with Agilent 7673 and other robotic arm autosamplers that use 12 x 32 mm screw top vials
- Excellent for long-term storage
- Clear vials type 1 borosilicate glass, 33 expansion glass
- Amber vials for light sensitive samples

Description	Qty	Item No.
Clear Screw Vial	100/pk	123242
Clear Screw Vial with Graduated Label	100/pk	123248
Amber Screw Vial with Graduated Label	100/pk	123253



## Combo Packs

Description	Qty	Item No.
Clear Vial, Cap, PTFE/Silicone	100/pk	123243
Clear Vial, Cap, PTFE/Silicone/PTFE	100/pk	123247
Label Clear Vial, Cap, PTFE/Silicone	100/pk	123250
Label Clear Vial, Cap, Slit PTFE/Silicone	100/pk	123252
Label Amber Vial, Cap, PTFE/Silicone	100/pk	123254



## Pre-Stuffed Caps for 9 mm Vials

- Fits 9 mm screw thread vials for Agilent 7673 and other robotic arm autosamplers that use 12 x 32 mm screw top vials
- Caps are pre-stuffed with various seal materials

Description	Qty	Item No.
PTFE	100/pk	309041
PTFE/Silicone Rubber	100/pk	309042
PTFE/Pre-slit Silicone	100/pk	309044
PTFE/Silicone/PTFE	100/pk	309045
PTFE/Silicone Rubber - Red Cap	100/pk	309042R

# Vials, Caps and Seals

## HPLC Vials



### 1.2 mL Waters® 96 Style Shell Vial

- Matches the Waters vial design; 8 x 40 mm (8 x 45 mm with cap, included)
- Made from Type 1 borosilicate glass except as noted
- Polyethylene cap is pre-scored in a star design for easier syringe penetration
- Insert available for small-volume sampling; fits into the cap

Description	Qty	Item No.
200 µL Insert, Glass	100/pk	053852
8 mm Snap Plug for Waters 96 Vial	100/pk	308051

### Combo Pack

Description	Qty	Item No.
1.2 mL Clear Shell Vial with Polyethylene Cap	100/pk	084242
1.2 mL Amber Shell Vial with Plug	100/pk	084252
1 mL Polypropylene Tapered Shell Vial with Polypropylene Cap	100/pk	084261

Shown above left: 084242, right: 084261.



### 1 mL 8 x 40 mm Crimp Top Vials & Caps

- For Waters 96 Vial Tray
- Tapered bottom for microsampling work
- Use standard 8 mm aluminum crimp caps or polyethylene plug caps
- Vials are made from type 1 borosilicate glass

Description	Material	Qty	Item No.
1.0 mL Tapered Crimp Top Vial*		125/pk	084051
8 mm Crimp Cap and Std. Seal	PTFE/Rubber	100/pk	308001
8 mm Crimp Cap and Seal TT	PTFE/Sil./PTFE	100/pk	308401
Plug Cap for 8 mm Vials Polyethylene		100/pk	308021

\* 4 pack minimum order



### Combo Pack

Description	Qty	Item No.
1.0 mL Vial, Cap, Std. Seal*	100/pk	084071
1.0 mL, with PE Plug Cap*	100/pk	084091

\* 5 pack minimum order

# Miscellaneous Vials



## 0.8 mL, 8 x 30 mm Shell Vial

- A handy alternative to crimp-top vials
- Comes complete with polyethylene plug cap; just push to seal
- Cap has 0.5 mm thickness in needle penetration zone for easy piercing
- Not for use with autosamplers that pressurize the vial
- Type 1 borosilicate glass

Description	Qty	Item No.
Shell Vial and Polyethylene Plug	100/pk	083042



## 4 mL Shell Vial

- No need to crimp or assemble screw caps
- Polyethylene plug cap included; just push to seal
- Type 1 borosilicate glass

Description	Qty	Item No.
Shell Vial with Plug	100/pk	154541



## 12 x 32 mm Shell Vials

- Alternative to crimp or screw top vials; just push to seal cap
- Can be used in most autosamplers except robot arm types, and autosamplers that pressurize the vial (Not usable with Agilent 7673/83A and 1090A autosamplers)
- Polyethylene plug cap included; the needle pierces the cap directly
- Type 1 borosilicate glass

Description	Qty	Item No.
2 mL Clear Shell Vial with Plug Cap	100/pk	123332
2 mL Amber Shell Vial with Plug Cap	100/pk	123362



## Did you know?

Don't have a part number or can't find a product? Using our online product filters at [www.ChromRes.com](http://www.ChromRes.com) helps you find the products you are looking for even faster!

## Miscellaneous Vials and Seals



### Reaction Vials

These minivials are useful for micro and semi-micro scale reactions or concentration work. The vials have thick walls, conical tapered interiors and come complete with PTFE-faced silicone liners and open-hole screw caps. Vials have graduation marks and are made from Type 1 borosilicate glass. Available in 1.0, 3.0, 5.0, and 10.0 mL vials shown above from left to right.

Description	Thread Size	Qty	Item No.
1.0 mL Clear Vial	13-425	12/pk	099420
3.0 mL Clear Vial	20-400	12/pk	099430
5.0 mL Clear Vial	20-400	12/pk	099440
10.0 mL Clear Vial	20-400	12/pk	099450
10.0 mL Amber Vial	20-400	12/pk	099452



### 2.5 mL, 12 x 40 mm Vial

- Fits Thermo Instruments AS 800, ICI LC1600, Pharmacia LKB 2157-020
- Uses standard 11 mm crimp caps and seals listed on page 59
- Type 1 borosilicate glass vial

Description	Qty	Item No.
2.5 mL Clear Crimp Vial	100/pk	124001



### Soil Sample Septa

- GC-quality septa; specially developed for purge-and-trap analysis using soil sample jars in DynaSoils®, DynaTrap® and similar instruments
- Conditioned to be free of volatiles
- Also superior for EPA sampling
- 22 mm diameter and 3 mm thick, coated on one side with PTFE

Description	Qty	Item No.
22 mm Soil Sample Septa	100/pk	322545

# 15 x 45 mm Screw Vials



## 4.0 mL Vials

- Ideal for your most demanding sampling needs
- Recommended for pH-sensitive work and other highly critical applications
- Graduated label vials show the approximate volume of contents
- 13-425 threads
- Type 1 borosilicate glass
- Uses caps and seals listed on page 72

Description	Qty	Item No.
4.0 mL Clear Screw Vial	100/pk	154505
4.0 mL Amber Screw Vial	100/pk	154515
4.0 mL Clear Graduated Screw Vial	100/pk	154506
4.0 mL Amber Graduated Screw Vial	100/pk	154507

## Inserts

- Allows small volume sampling in 15 x 45 mm vials
- Shell inserts fit directly into the vial; 8 x 42 mm
- Tapered glass (6 x 41 mm) and tapered polyethylene (6 x 35 mm) inserts require a spring for support; the spring is reusable
- TriSpring inserts have a plastic support spring permanently attached
- Type 1 borosilicate glass, except as noted

Description	Qty	Item No.
300 $\mu$ L Tapered Insert*	100/pk	063951
300 $\mu$ L TriSpring Insert	100/pk	063961
250 $\mu$ L TriSpring Insert, Polypropylene	100/pk	063971

*Shown above from left to right.*

*\*Requires spring for support.*



## Combo Pack

Description	Qty	Item No.
4.0 mL Clear Vial, Cap, Seal ST	100/pk	154525
4.0 mL Clear Vial, Cap, Seal PTFE	100/pk	154545
4.0 mL Amber Vial, Cap, Seal ST	100/pk	154535



# Vials, Caps and Seals

## 15 x 45 mm Screw Vials



### 4.0 Pre-Assembled Screw Top Vials

- Completely pre-assembled with PTFE/Silicone seal and open-hole screw cap
- Type 1 borosilicate glass
- Cap is made from polypropylene

**Silicone Seal ST** - Made from white silicone rubber faced with a PTFE layer.

**Seal TT** - Premium-grade seal with two layers of PTFE. Coring is virtually eliminated.

Description	Qty	Item No.
4.0 mL Pre-assembled Vial ST	100/pk	154565
4.0 mL Pre-assembled Vial PTFE	100/pk	154575



### Caps and Seals

- Caps are made from polypropylene; open-hole design
- 12 mm caps (13-425 threads) fit the threads of 15 x 45 mm vials

**Silicone Seal ST** - Made from white silicone rubber faced with a PTFE layer.

**Seal PTFE** - 12 mm disk of pure PTFE. For one-time use; not resealable.

**Seal TT** - Premium-grade seal with two layers of PTFE. Coring is virtually eliminated.

**TruSeal™** - A Silicone/PTFE seal offers lower permeability and bleed than natural rubber, and resists degradation to 250°C. Because the TruSeal is soft, lower crimping force is recommended.

#### Cap

Description	Material	Qty	Item No.
12 mm Black Screw Cap	Polypropylene	100/pk	312115

#### Seals

Description	Material	Qty	Item No.
12 mm Silicone Seal ST	PTFE/Silicone	100/pk	312515
12 mm Seal TT	PTFE/Sil./PTFE	100/pk	311715
12 mm Seal PTFE	PTFE	100/pk	312005
12 mm TruSeal	PTFE/Silicone	100/pk	312565



## 1.2 mL, 2.5 mL Reduced Volume Polypropylene Vial

- Screw top polypropylene vial fits WISP® and other autosamplers directly
- Reduced volume and non-ionic makes it ideal for IC and HPLC applications
- Interior is tapered at the bottom to allow nearly complete sample withdrawal
- Uses the same 12 mm (13-425) screw caps and seals listed on page 72

Description	Qty	Item No.
2.5 mL Polypropylene Screw Vial	100/pk	154655



## Combo Pack

Description	Qty	Item No.
2.5 mL Vial, Cap, PTFE Seal	100/pk	154675



## We're on Twitter!



You can follow us on Twitter @ChromRes\_GC for our newest posts from CRS BLOGables, the most up to date product and company info, and even some pretty funny chemistry jokes from time to time!

## Sample Vials



### Sample Vials

- Ideal for sample storage; available in several sizes
- Vials are made from type 1 borosilicate glass
- Use PTFE-lined screw caps shown at right

#### Clear Sample Vials

Description		Qty	Item No.
	Dia. x Ht, mm	Cap Size	
1.8 mL	12 x 32	8-425	100/pk 123205
4 mL	15 x 45	13-425	100/pk 154505
8 mL	17 x 60	15-425	100/pk 176003
12 mL	19 x 65	15-425	200/pk 196503
16 mL	21 x 70	18-400	200/pk 217003
24 mL	27.5 x 57	24-400	100/pk 275705
40 mL	27.5 x 95	24-400	100/pk 279505

*Shown above from left to right in order listed.*

#### Amber Sample Vials

Description		Qty	Item No.
	Dia. x Ht, mm	Cap Size	
1.8 mL	12 x 32	8-425	100/pk 123215
4 mL	15 x 45	13-425	100/pk 154515
8 mL	17 x 60	15-425	100/pk 176005
12 mL	19 x 65	15-425	144/pk 196505
40 mL	27 x 98	24-400	100/pk 279515



### PTFE Lined Screw Caps

- Solid (no-hole) replacement screw caps for all of your sample vials and jars
- PTFE-faced foam seals are ultrasonically bonded to the inside of the caps
- Not autoclavable

Description	Qty	Item No.
8-425 Thread Screw Cap	100/pk	309925
13-425 Thread Screw Cap	100/pk	309935
15-425 Thread Screw Cap	100/pk	520110
18-400 Thread Screw Cap	100/pk	520310
20-400 Thread Screw Cap	100/pk	520210
22-400 Thread Screw Cap	100/pk	520410
24-400 Thread Screw Cap	100/pk	520510
38-400 Thread Screw Cap	100/pk	520810
48-400 Thread Screw Cap	100/pk	521110

# Headspace Vials - Crimp Top



## Rounded Bottom Vials

- Vial lip has a beveled shape (slightly raised inner edge) for better, tighter seals
- Type 1 borosilicate glass
- Dimensions are: Above Left: 10 mL, 23 x 46 mm; Above Right: 20 mL, 23 x 75 mm
- Vials use standard 20 mm aluminum crimp caps and seals shown on pages 76-77

Description	Qty	Item No.
10 mL Headspace Vial	100/pk	224601
20 mL Headspace Vial	100/pk	237501



## Combo Pack

Description	Qty	Item No.
10 mL Vial, Cap, Septum 3	100/pk	224621
10 mL Vial, Precleaned, press release seal	100/pk	224621A
20 mL Vial, Cap, Septum 3	100/pk	237521
20 mL Vial, Precleaned, press release seal	100/pk	237521A



## Flat Bottom Vials

- Flat bottom headspace vials for those who cannot use the rounded bottom style
- Vials use standard 20 mm aluminum crimp caps and seals shown on pages 76-77
- Dimensions are: 6 mL, 23 x 38 mm; 10 mL, 23 x 46 mm; 20 mL, 23 x 75 mm; 27 mL, 30 x 60 mm shown above left to right

Description	Qty	Item No.
6 mL Headspace Vial	100/pk	223801
10 mL Headspace Vial	100/pk	224604
20 mL Headspace Vial	100/pk	237504
27 mL Headspace Vial	100/pk	306001



## Combo Pack

Description	Qty	Item No.
6 mL Vial, Cap, Septum 3	100/pk	223821
6 mL Vial, Precleaned, press release seal	100/pk	223821A
10 mL Vial, Cap, Septum 3	100/pk	224624
20 mL Vial, Magnetic Cap, Septum 3	100/pk	237524

# Vials, Caps and Seals

## 20 mm Caps and Seals



### 20 mm Caps

**Standard Cap** - Made from lacquered aluminum with an open hole design. It fits 6 mL, 10 mL, 20 mL and 27 mL headspace vials.



**Safety Cap** - Specially designed to vent high-pressure gas at approximately 5 bar (78 psi). The safety cap is aluminum.

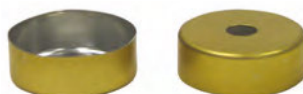

**Magnetic Cap** - Nickel plated steel cap is for use with autosamplers made by LEAP and CTC, and other autosamplers using a magnetic pick-up arm.



**Magnetic Ring Crimp Cap** - This is a 20 mm aluminum crimp cap, pre-assembled with an internal steel ring. The inner steel ring allows use with magnetic pick-up autosamplers while the outer aluminum cap can still be crimped with the 20 mm manual crimper and rechargeable electronic crimper on page 50 and 51.

#### Caps - No Seals

Description	Qty	Item No.
20 mm Crimp Cap <sup>1</sup>	100/pk	320001
20 mm Safety Crimp Cap <sup>1</sup>	100/pk	320301
20 mm Magnetic Crimp Cap <sup>2</sup>	100/pk	320605
20 mm Magnetic Ring Crimp Cap <sup>1</sup>	100/pk	320607

<sup>1</sup> Suitable for use with manual and battery powered crimpers (page 50 and 51).

<sup>2</sup> High Power Crimper (page 52-53) recommended.



### 20 mm Seals

**Septum 3** - Pure silicone rubber, 3 mm thick, coated with PTFE.



**Septum 2** - 2.4 mm thick silicone faced with PTFE.



**Soil Sample Septa** - This is a 20 mm version of our popular seal for soil sampling. Suitable for your most sensitive analysis; it is pre-conditioned to be free from volatiles. Layer of PTFE on silicone; 3 mm total thickness.



**Chlorobutyl Septum** - Gray. This is made from pure chlorobutyl rubber, 3 mm thick.



**Bellows Seal** - Chlorobutyl rubber faced with PTFE for superior sample protection. Only PTFE contacts the sample, while the soft outer ring of rubber makes a tight seal.

Description	Qty	Item No.
20 mm Septum 3	100/pk	320101
20 mm Septum 2	100/pk	320201
20 mm Chlorobutyl Septum (Gray)	100/pk	320401
20 mm Bellows Seal	100/pk	320501
20 mm Soil Sample Septum	100/pk	320545



## 20 mm Pre-Stuffed Caps

Seals are pre-stuffed for added convenience and lower contamination risk. These fit all standard 6 mL, 10 mL, 20 mL and 27 mL headspace vials. Aluminum caps may be crimped using the 20 mm electronic crimper listed on page 51.

**Standard Cap** - Made from lacquered aluminum; open hole design.

**Safety Cap** - Specially designed to vent high-pressure gas at approximately 5 bar (78 psi). The safety cap is aluminum.

**Magnetic Cap** - Made from nickel-plated steel for use with magnetic pick-up arm autosamplers. Not suitable for use with the rechargeable electronic crimper or decapper. The High Power Crimper on page 52 and 53 is recommended.

**Septum 3** - Pure silicone rubber coated with PTFE.

**Septum 2** - Silicone faced with PTFE.

**Butyl Septum** - Black. Standard butyl rubber (not chlorobutyl) available pre-stuffed in the aluminum cap. Good for routine use.

**Bellows Seal** - Chlorobutyl rubber faced with PTFE for superior sample protection. Only PTFE contacts the sample, while the outer ring of rubber makes a tight seal.

Description	Qty	Item No.
Aluminum Crimp Cap <sup>1</sup> /Septum 3	100/pk	320121
Safety Crimp Cap <sup>1</sup> /Septum 3	100/pk	320122
Magnetic Crimp Cap <sup>2</sup> /Septum 3	100/pk	320123
Aluminum Crimp Cap <sup>1</sup> /Blue/White Septa	100/pk	320130
Aluminum Crimp Cap <sup>1</sup> /Septum 2	100/pk	320221
Safety Crimp Cap <sup>1</sup> /Septum 2	100/pk	320222
Magnetic Crimp Cap <sup>2</sup> /Septum 2	100/pk	320223
Aluminum Crimp Cap <sup>1</sup> /Black Butyl	100/pk	320421
Aluminum Crimp Cap <sup>1</sup> /Bellows Seal	100/pk	320521
Magnetic Crimp Cap <sup>2</sup> /Septum 3	100/pk	320610

<sup>1</sup> Suitable for use with manual and battery powered crimpers (page 50 and 51).

<sup>2</sup> High Power Crimper (page 52-53) recommended.



## Chat with us!

If you have a question for us, get an immediate answer with our live chat feature online at [www.ChromRes.com](http://www.ChromRes.com).



## Headspace Vials - Screw Tops



### Precision-Thread Vials

- Made from Type 1 borosilicate glass
- Vials can be used either for traditional headspace analyses or SPME
- Use with magnetic screw caps and seals shown at right
- Vials have rounded bottoms and 18 mm diameter necks.
- Dimensions are: Above left: 10 mL, 23 x 46 mm;  
Above right: 20 mL, 23 x 76 mm

Description	Qty	Item No.
10 mL Clear Screw Headspace Vial	100/pk	224608
10 mL Amber Screw Headspace Vial	100/pk	224609
20 mL Clear Screw Headspace Vial	100/pk	237508
20 mL Amber Screw Headspace Vial	100/pk	237509



### Combo Pack

Description	Qty	Item No.
10 mL Clear, Cap, PTFE/Silicone	100/pk	224611
20 mL Clear, Cap, PTFE/Silicone	100/pk	237511



### Magnetic Precision-Thread Screw Caps with Seals

- Use with precision-thread vials shown at left
- Flat upper surface assures strong magnetic bond
- 8 mm center hole also suitable for SPME

Caps come with 18 mm liners already installed. Liners are available in a range of hardness, as measured by Shore A durometer. Liners are thinner than typical crimp top headspace liner seals, so they may be more easily pierced by SPME sampling systems.

Description	Thickness	Shore A	Qty	Item No.
White PTFE/Blue Silicone	1.3 mm	35	100/pk	320125
Gray PTFE/Red Butyl Rubber	1.6 mm	55	100/pk	320128
Red PTFE/White Silicone	1.3 mm	45	100/pk	320124
Blue PTFE/White Silicone	1.5 mm	55	100/pk	320126
Chlorobutyl			100/pk	320129

# EPA Sampling Vials



## Bulk EPA Vials

- Meet specifications for water sampling under EPA 40 CFR
- Type 1 borosilicate glass
- Dimensions: Above left: 24 mL, 27.5 x 57 mm;  
Above right: 40 mL, 27.5 x 95 mm
- All have 24-400 thread and use 24 mm screw caps with 22 mm seals shown at right

Description	Qty	Item No.
24 mL Clear EPA Vial	100/pk	275705
24 mL Amber EPA Vial	100/pk	275805
40 mL Clear EPA Vial	100/pk	279505
40 mL Amber EPA Vial	100/pk	279515

## Combo Pack

Description	Qty	Item No.
24 mL Clear Vial, Cap, Seal	100/pk	275725
24 mL Amber Vial, Cap, Seal	100/pk	275905
40 mL Clear Vial, Cap, Seal	100/pk	279525
40 mL Amber Vial, Cap, Seal	100/pk	279535

\*All combo packs listed above come with seal 322515 and cap 324115 shown at right



## 24 mm Caps

- 24-400 or 24-414 threads; made from polypropylene. Both fit 24-400 thread vials.
- The 24-414 threads caps are deeper, and are recommended for use with thick seals
- Open-hole design

Description	Qty	Item No.
Black Screw Cap, 24-400	100/pk	324115
Black Screw Cap, 24-414	100/pk	324114
Preassembled White Screw Caps		
Screw Cap, 24-414 and Seal	100/pk	324415
Screw Cap, 24-414 and Seal, Level 3	100/pk	324425



## 22 mm Seals

- All seals for headspace are 22 mm diameter
- Seals are made from silicone with a PTFE layer, except PTFE Disk

Description	Qty	Item No.
Standard Seal, PTFE/Silicone	100/pk	322515
PTFE/Silicone	100/pk	322516
PTFE Disk	100/pk	322005
Economy PTFE/Silicone Septa	100/pk	322550
22 mm Soil Sample Septa	100/pk	322545

# Vials, Caps and Seals

## Pre-Assembled EPA Sampling Vials



### Pre-Staffed EPA Screw Caps

- Can be heated to 125°C for preparation per EPA protocols or for autoclaving
- The PTFE/Silicone seal is welded to the polypropylene cap so it cannot fall out
- Fits 20, 40 and 60 mL EPA vials. 24-414 threads.

Description	Qty	Item No.
24 mm Prestuffed EPA Caps	100/pk	324415
24-414 Cap with Bonded PTFE/Silicone Seal, Level 3	100/pk	324425



### Standard Pre-Assembled Vials

- Vial is completely pre-assembled, with PTFE/Silicone seal and open-hole cap
- Dimensions: 20 mL, 28 x 56 mm; 40 mL, 28 x 95 mm
- The seal is bonded to the open-hole polypropylene cap using a proprietary process without glue, so it cannot fall out
- Type 1 borosilicate glass

Description	Qty	Item No.
20 mL EPA Vials, Preassembled	100/pk	275745
40 mL EPA Vials, Preassembled	100/pk	279545

# Pre-Cleaned EPA Sampling Vials



## Pre-Cleaned & Pre-Assembled Vials

- Pre-cleaned EPA vials come pre-cleaned with cap and PTFE/Silicone seal
- Dimensions: 20 mL, 28 x 56 mm; 40 mL, 28 x 95 mm; 60 mL, 27 x 140 mm
- Vials are cleaned to Protocol B as specified in the EPA "Specifications and Guidance for Contaminant-Free Sample Containers"
- Type 1 borosilicate glass
- Level 3 - precleaned; sent to an independent lab for QC analysis. Vials comes with certificate.\*

Description	Qty	Item No.
20 mL Clear Precleaned EPA Vials	72/pk	275825
20 mL Amber Precleaned EPA Vials	72/pk	275835
40 mL Clear Precleaned EPA Vials	72/pk	279825
40 mL Amber Precleaned EPA Vials	72/pk	279835
60 mL Clear Precleaned EPA Vials	72/pk	271425
60 mL Amber Precleaned EPA Vials	72/pk	271435
<b>Level 3 Certificate</b>		
40 mL Clear Precleaned EPA Vial*	72/pk	279815
40 mL Amber Precleaned EPA Vial*	72/pk	279816

## Combo Pack

Description	Qty	Item No.
40 mL Clear EPA Vial Level 3 Certificate*	100/pk	279580

Combo pack listed above comes un-assembled with vial 279505 and level 3 certificate cap with bonded PTFE/Silicone Seal - 324425.

# Vials, Caps and Seals

## Crimp Caps (no seal)



### 8 mm Caps

These fit all standard 6, 7 and 8 mm diameter crimp vials and others with 8 mm lips.

Description	Qty	Item No.
Blank Crimp Cap (no seal)	100/pk	308501

### 11 mm Caps

These fit all common 12 x 32 mm (1.8 mL) crimp vials, both standard and wide mouth. Caps with standard seals are available silver, blue, green, gold, orange, purple, red and yellow.

Description	Qty	Item No.
Blank Crimp Cap (no seal)	100/pk	311501
Magnetic Crimp Cap (no seal)	100/pk	311002

### 20 mm Caps

These fit the 6 mL, 10 mL, 20 mL, 27 mL headspace vials.

Description	Qty	Item No.
Blank Crimp Cap (no seal)	100/pk	320001
Safety Crimp Cap (no seal)	100/pk	320301
Magnetic Crimp Cap (no seal)	100/pk	320605
Magnetic Ring Crimp Cap (no seal)	100/pk	320607



### Did you know?

We manage our inventory carefully so that you always get on time shipping!

# Crimp Caps Pre-Stuffed with Seals



## 8 mm Caps Pre-Stuffed with Seals

These fit all standard 6, 7 and 8 mm diameter crimp vials and others with 8 mm lips.

Description	Qty	Item No.
Crimp Cap/Standard Seal	100/pk	308001
Crimp Cap/Seal S	100/pk	308201
Crimp Cap/Seal TT	100/pk	308401
Crimp Cap/TruSeal	100/pk	308231



## 11 mm Caps Pre-Stuffed with Seals

Fits 12 x 32 mm (1.8 mL) crimp vials, standard and wide mouth.

Description	Qty	Item No.
Crimp Cap/Standard Seal, Silver	100/pk	311001
Crimp Cap/Standard Seal, Blue	100/pk	311001B
Crimp Cap/Standard Seal, Green	100/pk	311001G
Crimp Cap/Standard Seal, Gold	100/pk	311001GO
Crimp Cap/Standard Seal, Orange	100/pk	311001O
Crimp Cap/Standard Seal, Purple	100/pk	311001PU
Crimp Cap/Standard Seal, Red	100/pk	311001R
Crimp Cap/Standard Seal, Yellow	100/pk	311001Y
Crimp Cap/Seal S	100/pk	311201
Crimp Cap/Seal TT	100/pk	311401
Crimp Cap/TruSeal	100/pk	311231



## 20 mm Caps Pre-Stuffed with Seals

These fit the 6 mL, 10 mL, 20 mL, 27 mL headspace vials.

Description	Qty	Item No.
Aluminum Crimp Cap/Septum 3	100/pk	320121
Safety Crimp Cap/Septum 3	100/pk	320122
Magnetic Crimp Cap/Septum 3	100/pk	320123
Aluminum Crimp Cap/Septum 2	100/pk	320221
Safety Crimp Cap/Septum 2	100/pk	320222
Magnetic Crimp Cap/Septum 2	100/pk	320223
Aluminum Crimp Cap/Black Butyl	100/pk	320421
Aluminum Crimp Cap/Bellows Seal	100/pk	320521
Magnetic Crimp Cap/Septum 3	100/pk	320610



## Seal Descriptions

**Standard Seal** - Good for routine use; self-sealing.

**Seal S** - A quality PTFE/Silicone seal; silicone offers good sealing properties.

**Seal TT** - Premium-grade seal with two layers of PTFE. Coring is virtually eliminated.

**TruSeal™** - A Silicone/PTFE seal offers lower permeability and bleed than natural rubber, and resists degradation to 250°C. Because the TruSeal is soft, lower crimping force is recommended.

**Septum 3** - Pure silicone rubber coated with PTFE.

**Septum 2** - Silicone faced with PTFE.

**Butyl Septum** - Black. Standard butyl rubber (not chlorobutyl) available pre-stuffed in the aluminum cap. Good for routine use.

**Bellows Seal** - Chlorobutyl rubber faced with PTFE for superior sample protection. Only PTFE contacts the sample, while the outer ring of rubber makes a tight seal.



## Screw Caps and Seals



### Open Hole Screw Caps, Polypropylene

- 8 mm Screw Caps - 8-425 threads. Fit standard mouth 12 x 32 mm vials.
- 8 mm Wide Lip Screw Caps - 8-425 threads. Specially designed for Shimadzu, Hitachi and Jasco autosamplers. It fits standard 12 x 32 mm vials, but is made with a wider outer lip.
- 10 mm Screw Caps - 10-425 threads. Fits wide mouth 12 x 32 mm vials.
- 12 mm Screw Caps - 13-425 threads. Fits standard 15 x 45 mm (4 mL WISP) vials.

Description	Qty	Item No.
8 mm Black Screw Cap	100/pk	308115
8 mm Wide Lip Screw Cap	100/pk	309115
10 mm Black Screw Cap	100/pk	310115
12 mm Black Screw Cap	100/pk	312115
24 mm Screw Cap, 24-414	100/pk	324115
24 mm Screw Cap, 24-414	100/pk	324114



### Pre-Assembled Screw Caps

Using the open hole design screw caps shown above. Prestuffed with the following seals:

**Seal ST** - Made from white silicone rubber faced with a PTFE layer.

**Seal TT** - Premium-grade seal with two layers of PTFE. Coring is virtually eliminated.

**Septum 3** - Pure silicone rubber coated with PTFE.

**Septum 2** - Silicone faced with PTFE.

Description	Material	Qty	Item No.
<b>8 mm</b>			
Cap with Seal ST	PP/PTFE/Silicone	100/pk	309525
Cap with Seal TT	PP/PTFE/Sil./PTFE	100/pk	309585
<b>24-414</b>			
Cap and Seal	PTFE/Sil.	100/pk	324415
Cap and Seal Level 3	PTFE/Sil.	100/pk	324425



### Polyethylene Plug Caps

These are for use with screw or crimp top vials; not for use with shell vials. Do not use with systems that pressurize the vial. Plug 8-1 fits 7 x 40 mm and 8 x 30 mm vials. Plug 11-2 fits 12 x 32 mm standard mouth vials.

Description	Qty	Item No.
Plug 8-1	100/pk	308021
Plug 11-2	100/pk	311021



## PTFE-Lined Screw Caps

Solid (no-hole) replacement screw caps for all of your sample vials and jars. PTFE-faced foam seals are ultrasonically bonded to the inside of the caps. Not autoclavable.

Description	Qty	Item No.
8-425 Thread PTFE Lined Screw Cap	100/pk	309925
13-425 Thread PTFE Lined Screw Cap	100/pk	309935
15-425 Thread PTFE Lined Screw Cap	100/pk	520110
18-400 Thread PTFE Lined Screw Cap	100/pk	520310
20-400 Thread Screw Cap	100/pk	520210
22-400 Thread PTFE Lined Screw Cap	100/pk	520410
24-400 Thread PTFE Lined Screw Cap	100/pk	520510
38-400 Thread PTFE Lined Screw Cap	100/pk	520810
48-400 Thread PTFE Lined Screw Cap	100/pk	521110



## Magnetic Precision-Thread Screw Cap with Seals

Caps come with 18 mm liners already installed. Liners are thinner than typical crimp top headspace liner seals, so they may be more easily pierced by SPME sampling systems.

Description	Thickness	Shore A	Qty	Item No.
White PTFE/Blue Silicone	1.3 mm	35	100/pk	320125
Gray PTFE/Red Butyl Rubber	1.6 mm	55	100/pk	320128
Red PTFE/White Silicone	1.3 mm	45	100/pk	320124
Blue PTFE/White Silicone	1.5 mm	55	100/pk	320126
Chlorobutyl			100/pk	320129



### Did you know?

For more literature, look up our products at [www.ChromRes.com](http://www.ChromRes.com) and click on the documents tab!

## Seals



### Seals

**Silicone Seal ST** - Made from white silicone rubber faced with PTFE layer.

**Silicone Seal** - Similar to our Silicone ST Seal, except the PTFE layer is thicker for added protection. Cream colored PTFE on white silicone.

**Seal TT** - Premium-grade seal with two layers of PTFE. Coring is virtually eliminated.

**TruSeal™** - A Silicone/PTFE seal offers lower permeability and bleed than natural rubber, and resists degradation to 250°C. Because the TruSeal is soft, lower crimping force is recommended.

**Slit Seal** - Recommended for Hitachi, Jasco and Shimadzu autosamplers. Prescored for easy needle penetration. Use with standard mouth vials and wide lip caps.

**Seal PTFE** - Disks of pure PTFE. For one-time use; not resealable. The 7.5 mm size fits 8 mm crimp caps.

**Septum 3** - Pure silicone rubber, 3 mm thick, coated with PTFE.

**Septum 2** - 2.4 mm thick silicone faced with PTFE.

**Soil Sample Septa** - This is a 20 mm version of our popular seal for soil sampling. Suitable for your most sensitive analysis; it is pre-conditioned to be free from volatiles. Layer of PTFE on silicone; 3 mm total thickness.

**Chlorobutyl Septum** - Gray. This is made from pure chlorobutyl rubber, 3 mm thick.

**Bellows Seal** - Chlorobutyl rubber faced with PTFE for superior sample protection. Only PTFE contacts the sample, while the soft outer ring of rubber makes a tight seal.

Description	Qty	Item No.
7.5 mm Seal PTFE	100/pk	307001
8 mm Silicone Seal ST (Red)	100/pk	308515
8 mm Cream Silicone Seal	100/pk	308915
8 mm Seal TT	100/pk	308715
8 mm TruSeal	100/pk	308565
8 mm Slit Seal	100/pk	309715
9 mm Seal ST (Red)	100/pk	310515
9 mm Seal TT	100/pk	310615
9 mm Slit Seal	100/pk	310815
9 mm Seal PTFE	100/pk	310005
10 mm Seal PTFE	100/pk	310001
12 mm Silicone Seal ST (Red)	100/pk	312515
12 mm Natural Silicone Seal	100/pk	312915
12 mm Seal TT	100/pk	311715
12 mm TruSeal	100/pk	312565
12 mm Seal PTFE	100/pk	312005
18 mm Seal PTFE	100/pk	318005
20 mm Septum 3	100/pk	320101
20 mm Soil Sample Septum	100/pk	320545
20 mm Septum 2	100/pk	320201
20 mm Chlorobutyl Septum (Gray)	100/pk	320401
20 mm Bellows Seal	100/pk	320501
20 mm Seal PTFE	100/pk	320005
22 mm Standard Seal, PTFE/Silicone	100/pk	322515
22 mm PTFE/Silicone	100/pk	322516
22 mm PTFE Disk	100/pk	322005
22 mm Economy PTFE/Silicone Septa	100/pk	322550

# Accessories



## Autosampler Vial Racks

- Holds up to eighty 1.5 and 2 mL vials
- Flip the rack over and it holds up to 60 PCR or microcentrifuge tubes from 0.2 - 0.5 mL
- Made of autoclavable polypropylene, allowing great chemical resistance
- Racks can be anchored to one another with special pins supplied with each rack
- Supplied with two removable handles
- Frosted area on both sides for bar coding, labeling or writing
- Dimensions: 9-3/4" x 2-5/8 in x 1-1/16" (232 mm x 67 mm x 27 mm)
- Transparent lid is optional

Description	Qty	Item No.
Vial Rack, 80 Places, Blue	10	868880B
Vial Rack, 80 Places, Green	10	868880G
Vial Rack, 80 Places, Orange	10	868880O
Vial Rack, 80 Places, Pink	10	868880P
Vial Rack, 80 Places, Red	10	868880R
Vial Rack, 80 Places, Yellow	10	868880Y
Vial Rack, 80 Places, Assorted*	10	868880AS
Lid, Transparent	10	868880

\*Assorted colors: Blue, green, orange, pink, red, and yellow.



## 50 Position 1.8 mL Vial Rack

- Plastic racks, available in 50 position
- 50 position holds 1.8 mL vials
- Polyethylene racks are not autoclavable
- Dimensions: 50 position (for 1.8 mL) 4 in x 7-5/8 in x 1-1/8"

Description	Qty	Item No.
50 Position for 1.8 mL Vials Polyethylene	5/pk	868850



### Did you know?

We're on Facebook! Like and follow us @ChromRes or Chromatography Research Supplies, Inc.

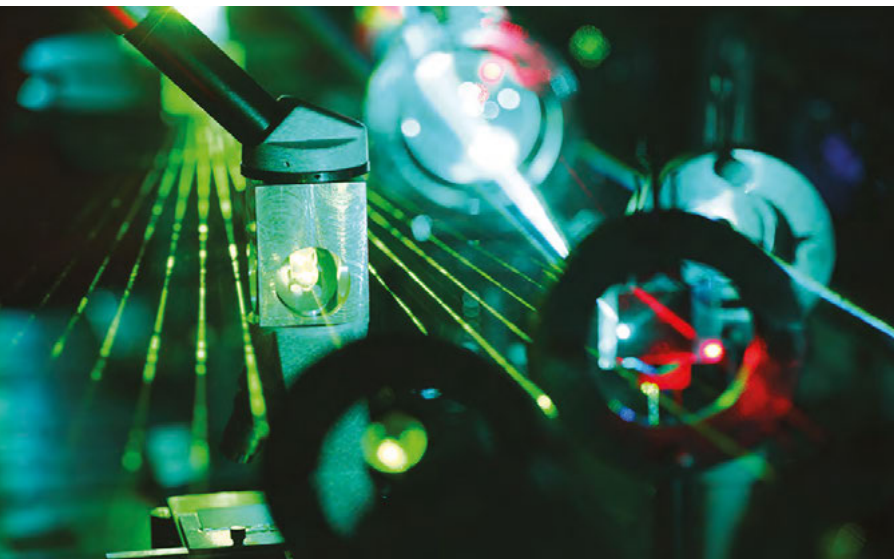

**CRS can offer premium parts for the laser and optics industry.**

**We can help you transform your innovations into tangible results.**





# Accessories

Accessories . . . . .	90
Solid Phase Extraction . . . . .	91-94
Mininert Valves & Reaction Vials . . . . .	95
Syringe Filters & Disposable Syringes . . . . .	96



## Accessories



### Universal Fused Silica Connectors

These quartz connectors will join columns from 0.25 mm to 0.53 mm ID. Handy for joining broken columns or attaching guard columns. Procedure: cut the capillary column with a ceramic column scribe; be sure the end is cut squarely. Insert the column into the appropriate leg of the connector to make a snug fit. Heat in the GC oven under carrier gas flow for one hour at 250°C, to fuse the column's polyimide coating to the wall of the union.

Description	Item No.
Universal Quartz Connector, 5/pk	207950
Universal Y-Splitter, each	207960



### Ferrule Remover

These are great for removing capillary GC ferrules. Insert into ferrule, give a slight twist, then pull out. Two removers are supplied for capillary ferrules from 0.4 mm to 0.8 mm ID.

Description	Item No.
Ferrule Remover, 2/pk	205315



### Column Scribe

Used for cutting capillary tubing. It is made from hard ceramic and easy to use. Just pull one smooth edge of the scribe, tilted about 45 degrees, across the column to lightly score the fused silica. Bend the column opposite the score and the column separates cleanly.

Description	Item No.
Column Scribe, 10/pk	205312



### Septa Pick

The Septa Pick is useful for removing small pieces of septa lodged in the threads and corners of the septum cap or injection port. It can also be used to remove small bits of graphite ferrule from the cap and fittings of column connectors; other small cleaning jobs.

Description	Item No.
Septa Pick	205465

# Solid Phase Extraction

Solid Phase Extraction cartridges from CRS provide fast and efficient sample clean-up and concentration prior to analysis. Cartridges use medical grade polypropylene tubes, porous polyethylene frits, and highly reproducible sorbents. SPE syringe cartridges are equipped with male luer tips, for versatility in connections and processing.

## Choosing the Proper Packing Type

**Reversed Phase** - C18, C8, and Phenyl bonded phases in various selections are available. Non-polar to moderately polar compounds in a polar matrix are retained by reversed-phase sorbents. Reversed-phase packings require conditioning with an organic solvent followed by an aqueous solvent prior to use. Elution of moderately polar compounds is often accomplished with mid-polarity solvents while non-polar compounds require less polar solvents.

**Normal Phase** - Silica, Florisil, Amino, Cyano, Diol and Alumina are usually used to retain polar compounds from non-polar matrices. Conditioning is carried out with a non-polar solvent. Elution is accomplished with more polar solvents. Compounds with pH basic functional groups are readily retained by silica. However, very polar compounds such as carbohydrates can be irreversibly retained on silica surface. In this case, a bonded and mid-polarity phase such as Diol or Amino is a better choice.

**Ion Exchange** - Strong anion (SAX) and cation (SCX) exchangers are available. Anions and cations are retained on the corresponding resin by exchanging the anion or cation in the buffers, 0.1 M - 0.5 M, or by changing the pH of elution solvent such that the sample compound is no longer charged. These resins are silica based and lose some exchange capacity with increasing organic solvent content in the sample.

## Solid Phase Extraction



### Reverse Phase SPE Cartridges, Non-Polar

#### C18 (ODS)

Description	Qty	Item No.
C18, 100 mg/1 mL	100/pk	186311
C18, 200 mg/3 mL	50/pk	186312
C18, 500 mg/3 mL	50/pk	186313
C18, 500 mg/6 mL	50/pk	186314
C18, 1000 mg/6 mL	30/pk	186315

#### C8 (Octyl)

Description	Qty	Item No.
C8, 100 mg/1 mL	100/pk	186321
C8, 200 mg/3 mL	50/pk	186322
C8, 500 mg/3 mL	50/pk	186323
C8, 500 mg/6 mL	50/pk	186324
C8, 1000 mg/6 mL	30/pk	186325

#### Phenyl

Description	Qty	Item No.
Phenyl, 100 mg/1 mL	100/pk	186341
Phenyl, 200 mg/3 mL	50/pk	186342
Phenyl, 500 mg/3 mL	50/pk	186343
Phenyl, 500 mg/6 mL	50/pk	186344
Phenyl, 1000 mg/6 mL	30/pk	186345



## Non-Silica SPE Cartridges

### Alumina A

Description	Qty	Item No.
Alumina A, 100 mg/1 mL	100/pk	186461
Alumina A, 200 mg/3 mL	50/pk	186462
Alumina A, 500 mg/3 mL	50/pk	186463
Alumina A, 500 mg/6 mL	50/pk	186464
Alumina A, 1000 mg/6 mL	30/pk	186465

### Alumina B

Description	Qty	Item No.
Alumina B, 100 mg/1 mL	100/pk	186471
Alumina B, 200 mg/3 mL	50/pk	186472
Alumina B, 500 mg/3 mL	50/pk	186473
Alumina B, 500 mg/6 mL	50/pk	186474
Alumina B, 1000 mg/6 mL	30/pk	186475

### Alumina N

Description	Qty	Item No.
Alumina N, 100 mg/1 mL	100/pk	186481
Alumina N, 200 mg/3 mL	50/pk	186482
Alumina N, 500 mg/3 mL	50/pk	186483
Alumina N, 500 mg/6 mL	50/pk	186484
Alumina N, 1000 mg/6 mL	30/pk	186485

### Florisil™

Description	Qty	Item No.
Florisil, 100 mg/1 mL	100/pk	186491
Florisil, 200 mg/3 mL	50/pk	186492
Florisil, 500 mg/3 mL	50/pk	186493
Florisil, 500 mg/6 mL	50/pk	186494
Florisil, 1000 mg/6 mL	30/pk	186495

## Solid Phase Extraction



### Normal Phase SPE Cartridges, Polar

#### Silica

Description	Qty	Item No.
Silica, 100 mg/1 mL	100/pk	186361
Silica, 200 mg/3 mL	50/pk	186362
Silica, 500 mg/3 mL	50/pk	186363
Silica, 500 mg/6 mL	50/pk	186364
Silica, 1000 mg/6 mL	30/pk	186365

#### Diol

Description	Qty	Item No.
Diol, 100 mg/1 mL	100/pk	186391
Diol, 200 mg/3 mL	50/pk	186392
Diol, 500 mg/3 mL	50/pk	186393
Diol, 500 mg/6 mL	50/pk	186394
Diol, 1000 mg/6 mL	30/pk	186395

#### Cyano (CN)

Description	Qty	Item No.
Cyano, 100 mg/1 mL	100/pk	186381
Cyano, 200 mg/3 mL	50/pk	186382
Cyano, 500 mg/3 mL	50/pk	186383
Cyano, 500 mg/6 mL	50/pk	186384
Cyano, 1000 mg/6 mL	30/pk	186385

#### Amino (NH<sub>2</sub>)

Description	Qty	Item No.
Amino, 100 mg/1 mL	100/pk	186371
Amino, 200 mg/3 mL	50/pk	186372
Amino, 500 mg/3 mL	50/pk	186373
Amino, 500 mg/6 mL	50/pk	186374
Amino, 1000 mg/6 mL	30/pk	186375

### Ion Exchange SPE Cartridges

#### SAX

Description	Qty	Item No.
SAX, 100 mg/1 mL	100/pk	186411
SAX, 200 mg/3 mL	50/pk	186412
SAX, 500 mg/3 mL	50/pk	186413
SAX, 500 mg/6 mL	50/pk	186414
SAX, 1000 mg/6 mL	30/pk	186415

#### SCX

Description	Qty	Item No.
SCX, 100 mg/1 mL	100/pk	186421
SCX, 200 mg/3 mL	50/pk	186422
SCX, 500 mg/3 mL	50/pk	186423
SCX, 500 mg/6 mL	50/pk	186424
SCX, 1000 mg/6 mL	30/pk	186425

# Mininert® Valves & Reaction Vials



## Mininert Valves

These are unique push-button PTFE vial closures featuring inertness and syringe access without exposure of the vial contents. When used with a glass vial, only PTFE and glass are in contact with the sample. A silicone rubber gasket above the PTFE valve stem (isolated from the contents) provides a seal for the needle and prevents leakage or exposure of the contents during sampling. Push the green button to open, insert the needle and take sample, withdraw the needle, then push the red button to close. The needle seal septum may be replaced as needed with the valve closed to avoid exposing contents. Mininert valves can be used up to 48°C. Packages of 12.

Description	Thread Size	Item No.
13 mm Screw Cap 12/pk	13-425	614158
15 mm Screw Cap 12/pk	15-425	614160
18 mm Screw Cap 12/pk	18-400	614161
20 mm Screw Cap 12/pk	20-400	614170
24 mm Screw Cap 12/pk	24-400	614163
20 mm Crimp Cap 12/pk		614250
Replacement Septa, 50/pk		644350



Mininert Septum Installing Tool, each

644850



## Reaction Vials

These are useful for micro and semi-micro scale reactions or concentration work. The vials have thick walls, conical tapered interiors and come complete with PTFE-faced silicone liners and open-hole screw caps. Vials have graduation marks. Made from borosilicate glass. Packages of 12.

Description	Thread Size	Item No.
1.0 mL Clear Vials 12/pk	13-425	099420
3.0 mL Clear Vials 12/pk	20-400	099430
5.0 mL Clear Vials 12/pk	20-400	099440
10.0 mL Clear Vials 12/pk	20-400	099450



## Syringe Filters & Disposable Syringes



### Syringe Filters

We offer a wide range of syringe filters for most sample clean up applications. Filter housings are made from polypropylene and have luer hubs to fit all luer lock syringes. Two membrane materials are available; Nylon (hydrophilic) for general filtration of aqueous samples and many solvents, and PTFE for gases, virtually all solvents, and highly corrosive acids and bases. PTFE can be used with aqueous samples by pre-wetting with methanol.

- 4 mm size - Low sample hold-up of less than 10  $\mu$ L. 100/pk
- 17 mm size - For general laboratory sampling. Filters have higher sample capacity than the 4 mm size. Maximum pressure for filtering is 5 bar (75 psi). 100/pk
- 30 mm size - For all around lab use. The 30 mm diameter allows greater throughput when hold-up of some sample is not critical. Maximum pressure is 5 bar (75 psi). 100/pk

Description	Item No
4 mm Nylon Filter, 0.2 micron 100/pk	189000
4 mm Nylon Filter, 0.45 micron 100/pk	189001
4 mm PTFE Filter, 0.2 micron 100/pk	189002
4 mm PTFE Filter, 0.45 micron 100/pk	189003
17 mm Nylon Filter, 0.2 micron 100/pk	186502
17 mm Nylon Filter, 0.45 micron 100/pk	186503
17 mm PTFE Filter, 0.2 micron 100/pk	186500
17 mm PTFE Filter, 0.45 micron 100/pk	186501
30 mm Nylon Filter, 0.2 micron 100/pk	186055
30 mm Nylon Filter, 0.45 micron 100/pk	186054
30 mm PTFE Filter, 0.2 micron 100/pk	186057
30 mm PTFE Filter, 0.45 micron 100/pk	186058

### Disposable Syringes

Useful for sample preparation, especially when used with CRS syringe filters. Syringes are made from polypropylene and polyethylene and are silicone-free. Extractables are minimized when compared with rubber-tipped plunger syringes. Syringes are individually wrapped in sterile "peel packs." Packages of 100.

Description	Item No.
3 mL 100/pk	186603
5 mL 100/pk	186605
10 mL 100/pk	186610
20 mL 100/pk	186620



## Product by GC Manufacturer

For Agilent Instruments . . . . .	98-99
For Bruker Instruments . . . . .	100-101
For PerkinElmer Instruments . . . . .	102-103
For Shimadzu Instruments . . . . .	104-105
For Thermo Instruments . . . . .	106-107

# Product by GC Manufacturer

## For Agilent Instruments

### Graphite Ferrules



#### Capillary Column Ferrules

Description	For Capillary Sizes - ID	Item No.
1/16" to 0.4 mm	0.25 mm	211104
1/16" to 0.5 mm	0.32 mm	211105
1/16" to 0.8 mm	0.53 mm	211108
1/16" to 1.0 mm	0.65 mm	211110
1/16" to 1.2 mm	0.75 mm	211112



#### Short Ferrules for Agilent Inlets\*

Description	For Capillary Sizes - ID	Item No.
1/16" to 0.4 mm	0.10 - 0.25 mm	211164
1/16" to 0.5 mm	0.32 mm	211165
1/16" to 0.8 mm	0.45 - 0.53 mm	211168
1/16" to 1.0 mm	0.53 - 0.65 mm	211160

\*short ferrules for Agilent inlet systems: 5890, 6890 and 7890.

### Vespel®/Graphite Ferrules - SP-22 (60%/40%)



#### Capillary Column Ferrules

Description	For Capillary Sizes - ID	Item No.
1/16" to 0.3 mm	0.10	213103
1/16" to 0.4 mm	0.18 - 0.25 mm	213104
1/16" to 0.5 mm	0.32 mm	213105
1/16" to 0.8 mm	0.53 mm	213108
1/16" to 1.0 mm	0.65 mm	213110



#### Short Ferrules for Agilent Inlet\*

Description	For Capillary Sizes - ID	Item No.
1/16" to 0.3 mm	0.10 - 0.18 mm	213163
1/16" to 0.4 mm	0.25 mm	213164
1/16" to 0.5 mm	0.32 mm	213165
1/16" to 0.8 mm	0.53 mm	213168

\*Short ferrules for Agilent Inlet systems: 5890, 6890 and 7890

### Vespel®/Graphite Ferrules - SP-21 (85%/15%)



#### Capillary Column Ferrules

Description	For Capillary Sizes - ID	Item No.
1/16" to 0.3 mm	0.10	215103
1/16" to 0.4 mm	0.18 - 0.25 mm	215104
1/16" to 0.5 mm	0.32 mm	215105
1/16" to 0.8 mm	0.53 mm	215108
1/16" to 1.0 mm	0.65 mm	215110



#### Short Ferrules for Agilent Inlet\*

Description	For Capillary Sizes - ID	Item No.
1/16" to 0.4 mm	0.25 mm	215164
1/16" to 0.5 mm	0.32 mm	215165
1/16" to 0.8 mm	0.53 mm	215168

\*Short ferrules for Agilent Inlet systems: 5890, 6890 and 7890

## Graphite Liner Ferrules



Description	For Capillary Sizes - ID	Item No.
Graphite Liner Seal, 6.5 mm ID	0.53 - 0.65 mm	216652

## Premium Septa

GC	Septum Size
5880A, 5890, 6890, 6850, 7820, 7820A, 7890A	11 mm
On-column injection	5 mm

## BTO<sup>®</sup>



## Advanced Green 3<sup>™</sup>



Description	Qty	Item No.
5 mm CenterGuide	50/pk	298787
7/16" (11 mm) CenterGuide	50/pk	298717
7/16" (11 mm) CenterGuide	100/pk	298718
5 mm CenterGuide	50/pk	246525

Description	Qty	Item No.
7/16" (11 mm) CenterGuide	50/pk	246225
7/16" (11 mm) CenterGuide	100/pk	246228
5 mm CenterGuide	50/pk	239597

## Marathon<sup>™</sup>



Description	Qty	Item No.
7/16" (11 mm) CenterGuide	50/pk	239297
7/16" (11 mm) CenterGuide	100/pk	239888

# Product by GC Manufacturer

## For Bruker Instruments (former Varian)

### Graphite Ferrules



#### Capillary Column Ferrules

Description	For Capillary Sizes - ID	Item No.
1/16" to 0.4 mm	0.25 mm	211104
1/16" to 0.5 mm	0.32 mm	211105
1/16" to 0.8 mm	0.53 mm	211108
1/16" to 1.0 mm	0.65 mm	211110
1/16" to 1.2 mm	0.75 mm	211112

### Graphite Liner Ferrules



Description	Item No.
Graphite Liner Ferrule, each	211550

### Vespel®/Graphite Ferrules - SP-22 (60%/40%)



#### Capillary Column Ferrules

Description	For Capillary Sizes - ID	Item No.
1/16" to 0.3 mm	0.10 mm	213103
1/16" to 0.4 mm	0.18 - 0.25 mm	213104
1/16" to 0.5 mm	0.32 mm	213105
1/16" to 0.8 mm	0.53 mm	213108
1/16" to 1.0 mm	0.65 mm	213110

### Vespel®/Graphite Ferrules - SP-21 (85%/15%)



#### Capillary Column Ferrules

Description	For Capillary Sizes - ID	Item No.
1/16" to 0.3 mm	0.10 mm	215103
1/16" to 0.4 mm	0.18 - 0.25 mm	215104
1/16" to 0.5 mm	0.32 mm	215105
1/16" to 0.8 mm	0.53 mm	215108
1/16" to 1.0 mm	0.65 mm	215110

## Premium Septa

Inlet	Septum Size
1177	9 mm
1040/41/60/61	3/8" (9.5 mm)
1075/77/78, 1079, 1093/94 SPI	11.5 mm

## BTO®



## Advanced Green 3™



Description	Qty	Item No.
9 mm CenterGuide	50/pk	298713
9.5 mm	50/pk	298705
11.5 mm CenterGuide	50/pk	298777

Description	Qty	Item No.
9 mm CenterGuide	50/pk	246713
9.5 mm	50/pk	246124
11.5 mm CenterGuide	50/pk	246725

## Marathon™



Description	Qty	Item No.
9 mm CenterGuide	50/pk	239779
11.5 mm CenterGuide	50/pk	239798



## For PerkinElmer Instruments

### Graphite Ferrules



#### Reducing Ferrules

Description	For Capillary Sizes - ID	Item No.
1/8" to 0.4 mm	0.25 mm	211204
1/8" to 0.5 mm	0.32 mm	211205
1/8" to 0.8 mm	0.53 mm	211208
1/16", two hole 0.5 mm; each	0.32 mm	211222



#### Reducing Ferrules

Description	For Tubing Sizes - ID	Item No.
1/8" to 1/16"	1/16 im	211210

### Vespel®/Graphite Ferrules - SP-22 (60%/40%)



#### Reducing Ferrules

Description	For Capillary Sizes - ID	Item No.
1/8" to 0.4 mm	0.25 mm	213204
1/8" to 0.5 mm	0.32 mm	213205
1/8" to 0.8 mm	0.53 mm	213208
1/8", two-holes 0.5 mm, each	0.32 mm	213222
1/8", two-holes 0.8 mm, each	0.53 mm	213228



#### Reducing Ferrules

Description	For Tubing Sizes - OD	Item No.
1/8" to 1/16"	1/16"	213210

### Vespel®/Graphite Ferrules - SP-21 (85%/15%)



#### Reducing Ferrules

Description	For Capillary Sizes - ID	Item No.
1/8" to 0.4 mm	0.25 mm	215204
1/8" to 0.5 mm	0.32 mm	215205
1/8" to 0.8 mm	0.53 mm	215208



#### Reducing Ferrules

Description	For Tubing Sizes - OD	Item No.
1/8" to 1/16"	1/16" 215210	Graphite

## O-Ring-for PerkinElmer Autosys XL or Clarus



Description	Item No.
O-Ring, 10/pk	216637

## Premium Septa

GC	Septum Size
Sigma Series, 900, 990, 8000 Series	11 mm
Auto SYS™, Auto SYS XL	11 mm

## BTO®



Description	Qty	Item No.
7/16" (11 mm) CenterGuide	50/pk	298717
7/16" (11 mm) CenterGuide	100/pk	298718

## Advanced Green 3™



Description	Qty	Item No.
7/16" (11 mm) CenterGuide	50/pk	246225
7/16" (11 mm) CenterGuide	100/pk	246228

## Marathon™



Description	Qty	Item No.
7/16" (11 mm) CenterGuide	50/pk	239297
7/16" (11 mm) CenterGuide	100/pk	239888

# Product by GC Manufacturer

## For Shimadzu Instruments

### Graphite Ferrules



Description	Item No.
5 mm Shimadzu 5 mm OD columns	211500



### Capillary Column Ferrules

Description	For Capillary Sizes - ID	Item No.
Shimadzu 17A, 2010 & 2014 GC's, 0.4 mm	0.25 mm and less	211174
Shimadzu 17A, 2010 & 2014 GC's, 0.5 mm	0.32 mm	211175
Shimadzu 17A, 2010 & 2014 GC's, 0.8 mm	0.53 mm	211178

### Graphite Liner Seals; O-Rings



Description	Item No.
Graphite Liner Seal, 10/pk	211195
Graphite O-Ring, Split, 10/pk	216638
Graphite O-Ring, Splitless, 10/pk	216639

## Premium Septa

GC

Septum Size

9A, 14, 15A, 16, 17A

Plug

2010, 2014

Plug

## BTO<sup>®</sup>

## Advanced Green 3<sup>™</sup>



Description	Qty	Item No.
Septa Plug	50/pk	298735

Description	Qty	Item No.
Septa Plug	50/pk	246424

## Marathon<sup>™</sup>



Description	Qty	Item No.
Septa Plug	50/pk	239498

## For Thermo Instruments

### Graphite Ferrules



#### M8 Nut Ferrules

Description	Item No.
0.5 mm ID	211905
0.8 mm ID	211908



#### Cup Ferrules - M4 Nut

Description	For Capillary Sizes - ID	Item No.
0.28 mm ID	0.10 mm	211982-10
0.38 mm ID	0.25 mm	211983-10
0.48 mm ID	0.32 mm	211984-10
0.80 mm ID	0.53 mm	211988-10

### Graphite Liner Seal



Description	Item No.
5 mm Graphite Seal, 2/pk	216949
8 mm Graphite Liner Seal, each	216948

## Premium Septa

GC	Septum Size
9001, GCQ	9 mm
Trace 1300 Series	11 mm
PTV Injector	1/2" (12.7mm)
Fisons/Carlo Erba 8000 Series, Trace, Focus Split/Splitless	17 mm

## BTO®



Description	Qty	Item No.
9 mm CenterGuide	50/pk	298713
7/16" (11 mm) CenterGuide	50/pk	298717
7/16" (11 mm) CenterGuide	100/pk	298718
1/2" (12.7 mm) CenterGuide	50/pk	298727
17 mm CenterGuide	50/pk	298817

## Advanced Green 3™



Description	Qty	Item No.
9 mm CenterGuide	50/pk	246713
7/16" (11 mm) CenterGuide	50/pk	246225
7/16" (11 mm) CenterGuide	100/pk	246228
1/2" (12.7 mm) CenterGuide	50/pk	246325
17 mm CenterGuide	50/pk	246624

## Marathon™



Description	Qty	Item No.
9 mm CenterGuide	50/pk	239779
7/16" (11 mm) CenterGuide	50/pk	239297
7/16" (11 mm) CenterGuide	100/pk	239888
1/2" (12.7 mm) CenterGuide	50/pk	239397
17 mm CenterGuide	50/pk	239698



# Item Number Index

053101	56, 58, 62, 66	123286	61	186363	94	186620	96
053151	56, 58, 62, 66	123315	62	186364	94	189000	96
053159	56, 58, 62, 66	123332	57, 69	186365	94	189001	96
053161	56, 58, 62, 66	123340	62	186371	94	189002	96
053171	56, 58, 62, 66	123341	56, 61	186372	94	189003	96
053852	68	123342	62	186373	94	196503	56, 74
063011	56, 60, 66	123343	61	186374	94	196505	74
063101	56, 60, 66	123344	61	186375	94	202200	25
063151	56, 60, 66	123362	69	186381	94	202202	25
063161	56, 60, 66	123371	61	186382	94	202212-B	10
063171	56, 60, 66	123385	62	186383	94	202212-B-QC	10
063181	56, 60, 66	123405	65	186384	94	202212-SS	10
063951	56, 71	123406	56, 65	186385	94	202212-SS-QC	10
063961	56, 71	123408	65	186391	94	202212D-B	10
063971	56, 71	123409	65	186392	94	202212D-B-QC	10
083042	57, 69	123415	65	186393	94	202212D-SS	10
084051	68	123425	64	186394	94	202212D-SS-QC	10
084071	68	123435	64	186395	94	202212L-B	10
084091	68	123491	58	186411	94	202212L-B-QC	10
084242	57, 68	124001	56, 70	186412	94	202212L-SS	10
084252	57, 68	154505	56, 71, 74	186413	94	202212L-SS-QC	10
084261	57, 68	154506	71	186414	94	202212M-V	14
099420	57, 70, 95	154507	71	186415	94	202212XL-B	10
099430	57, 70, 95	154515	71, 74	186421	94	202212XL-B-QC	10
099440	57, 70, 95	154525	71	186422	94	202212XL-SS	10
099450	57, 70, 95	154535	71	186423	94	202212XL-SS-QC	10
099452	70	154541	57, 69	186424	94	202213-B	10
123101	56, 60	154545	71	186425	94	202213-B-QC	10
123121	60	154565	72	186461	93	202213-SS	10
123135	62	154575	72	186462	93	202213-SS-QC	10
123165	64	154655	56, 73	186463	93	202213D-B	10
123175	56, 64	154675	73	186464	93	202213D-B-QC	10
123201	56, 58	176003	74	186465	93	202213D-SS	10
123202	58	176005	56, 74	186471	93	202213D-SS-QC	10
123203	58	186054	96	186472	93	202213L-B	10
123205	56, 62, 74	186055	96	186473	93	202213L-B-QC	10
123211	58	186057	96	186474	93	202213L-SS	10
123211A	60	186058	96	186475	93	202213L-SS-QC	10
123215	62, 74	186311	92	186481	93	202213M-SS	14
123221	58	186312	92	186482	93	202213M-SS-QC	14
123222	60	186313	92	186483	93	202213XL-B	10
123224	60	186314	92	186484	93	202213XL-B-QC	10
123225	62	186315	92	186485	93	202213XL-SS	10
123236	60	186321	92	186491	93	202213XL-SS-QC	10
123242	67	186322	92	186492	93	202216-B	7
123243	67	186323	92	186493	93	202216-B-QC	7
123247	67	186324	92	186494	93	202216-SS	7
123248	56, 67	186325	92	186495	93	202216-SS-QC	7
123250	67	186341	92	186500	96	202217-B	7
123252	67	186342	92	186501	96	202217-B-QC	7
123253	67	186343	92	186502	96	202217-SS	7
123254	67	186344	92	186503	96	202217-SS-QC	7
123255	56, 64	186345	92	186603	96	202230-4-PC	9
123281	56, 61	186361	94	186605	96	202230-6-PC	9
123284	61	186362	94	186610	96	202230-B	9

202230-B-QC	9	202232L-B-QC	8	202238D-6-PC	20	202283-SS	17
202230-SS	9	202232L-SS	8	202238D-B	20	202283-SS-QC	17
202230-SS-QC	9	202232L-SS-QC	8	202238D-B-QC	20	202283RP-B-QC	24
202230D-4-PC	9	202232M-V	14	202238D-SS	20	202283RP-SS-QC	24
202230D-6-PC	9	202232XL-4-PC	8	202238D-SS-QC	20	202284-B	17
202230D-B	9	202232XL-6-PC	8	202238DRP-B-QC	24	202284-B-QC	17
202230D-B-QC	9	202232XL-B	8	202238DRP-SS-QC	24	202284-SS	17
202230D-SS	9	202232XL-B-QC	8	202238L-4-PC	20	202284-SS-QC	17
202230D-SS-QC	9	202232XL-SS	8	202238L-6-PC	20	202285-B	12
202230L-4-PC	9	202232XL-SS-QC	8	202238L-B	20	202285-B-QC	12
202230L-6-PC	9	202233-B	8	202238L-B-QC	20	202285-SS	12
202230L-B	9	202233-B-QC	8	202238L-SS	20	202285-SS-QC	12
202230L-B-QC	9	202233-SS	8	202238L-SS-QC	20	202285D-B	12
202230L-SS	9	202233-SS-QC	8	202238LRP-B-QC	24	202285D-B-QC	12
202230L-SS-QC	9	202233D-B	8	202238LRP-SS-QC	24	202285D-SS	12
202230M-V	14	202233D-B-QC	8	202238RP-B-QC	24	202285D-SS-QC	12
202230XL-4-PC	9	202233D-SS	8	202238RP-SS-QC	24	202285L-B	12
202230XL-6-PC	9	202233D-SS-QC	8	202238XL-4-PC	20	202285L-B-QC	12
202230XL-B	9	202233L-B	8	202238XL-6-PC	20	202285L-SS	12
202230XL-B-QC	9	202233L-B-QC	8	202238XL-B	20	202285L-SS-QC	12
202230XL-SS	9	202233L-SS	8	202238XL-B-QC	20	202285XL-B	12
202230XL-SS-QC	9	202233L-SS-QC	8	202238XL-SS	20	202285XL-B-QC	12
202231-B	9	202233M-SS	14	202238XL-SS-QC	20	202285XL-SS	12
202231-B-QC	9	202233M-SS-QC	14	202238XLRP-B-QC	24	202285XL-SS-QC	12
202231-SS	9	202233XL-B	8	202238XLRP-SS-QC	24	202286-B	12
202231-SS-QC	9	202233XL-B-QC	8	202239-B	20	202286-B-QC	12
202231D-B	9	202233XL-SS	8	202239-B-QC	20	202286-SS	12
202231D-B-QC	9	202233XL-SS-QC	8	202239-SS	20	202286-SS-QC	12
202231D-SS	9	202234-B	18	202239-SS-QC	20	202286D-B	12
202231D-SS-QC	9	202234-B-QC	18	202239D-B	20	202286D-B-QC	12
202231L-B	9	202234-SS	18	202239D-B-QC	20	202286D-SS	12
202231L-B-QC	9	202234-SS-QC	18	202239D-SS	20	202286D-SS-QC	12
202231L-SS	9	202234RP-B-QC	24	202239D-SS-QC	20	202286L-B	12
202231L-SS-QC	9	202234RP-SS-QC	24	202239L-B	20	202286L-B-QC	12
202231M-SS	14	202235-B	18	202239L-B-QC	20	202286L-SS	12
202231M-SS-QC	14	202235-B-QC	18	202239L-SS	20	202286L-SS-QC	12
202231XL-B	9	202235-SS	18	202239L-SS-QC	20	202286XL-B	12
202231XL-B-QC	9	202235-SS-QC	18	202239XL-B	20	202286XL-B-QC	12
202231XL-SS	9	202236-B	17	202239XL-B-QC	20	202286XL-SS	12
202231XL-SS-QC	9	202236-B-QC	17	202239XL-SS	20	202286XL-SS-QC	12
202232-4-PC	8	202236-SS	17	202239XL-SS-QC	20	202287-B	13
202232-6-PC	8	202236-SS-QC	17	202256-B	18	202287-B-QC	13
202232-B	8	202236RP-B-QC	24	202256-SS	18	202287-SS	13
202232-B-QC	8	202236RP-SS-QC	24	202256-B-QC	18	202287-SS-QC	13
202232-SS	8	202237-B	17	202256-SS-QC	18	202287D-B	13
202232-SS-QC	8	202237-B-QC	17	202256RP-B-QC	24	202287D-B-QC	13
202232D-4-PC	8	202237-SS	17	202256RP-SS-QC	24	202287D-SS	13
202232D-6-PC	8	202237-SS-QC	17	202257-B	18	202287D-SS-QC	13
202232D-B	8	202238-4-PC	20	202257-SS	18	202287L-B	13
202232D-B-QC	8	202238-6-PC	20	202257-B-QC	18	202287L-B-QC	13
202232D-SS	8	202238-B	20	202257-SS-QC	18	202287L-SS	13
202232D-SS-QC	8	202238-B-QC	20	202270	25	202287L-SS-QC	13
202232L-4-PC	8	202238-SS	20	202272	25	202287-M-V	14
202232L-6-PC	8	202238-SS-QC	20	202283-B	17	202287XL-B	13
202232L-B	8	202238D-4-PC	20	202283-B-QC	17	202287XL-B-QC	13

# Item Number Index

202287XL-SS	13	202314-B	16	202325-SS-QC	21	202327L-SS	22
202287XL-SS-QC	13	202314-B-QC	16	202325D-B	21	202327L-SS-QC	22
202288-B	13	202314-SS	16	202325D-B-QC	21	202327XL-B	22
202288-B-QC	13	202314-SS-QC	16	202325D-SS	21	202327XL-B-QC	22
202288-SS	13	202314RP-B-QC	24	202325D-SS-QC	21	202327XL-SS	22
202288-SS-QC	13	202314RP-SS-QC	24	202325L-B	21	202327XL-SS-QC	22
202288D-B	13	202315-B	16	202325L-B-QC	21	202330	26
202288D-B-QC	13	202315-B-QC	16	202325L-SS	21	202332	26
202288D-SS	13	202315-SS	16	202325L-SS-QC	21	202350	26
202288D-SS-QC	13	202315-SS-QC	16	202325XL-B	21	202352	26
202288L-B	13	202318-B	16	202325XL-B-QC	21	202900	5
202288L-B-QC	13	202318-B-QC	16	202325XL-SS	21	202900MN	5
202288L-SS	13	202318-SS	16	202325XL-SS-QC	21	202902	5
202288L-SS-QC	13	202318-SS-QC	16	202326-4-PC	22	202902MN	5
202288M-SS	14	202318RP-B-QC	24	202326-6-PC	22	202903	5
202288M-SS-QC	14	202318RP-SS-QC	24	202326-B	22	202904	5
202288XL-B	13	202319-B	16	202326-B-QC	22	202905	5
202288XL-B-QC	13	202319-B-QC	16	202326-SS	22	202906	5
202288XL-SS	13	202319-SS	16	202326-SS-QC	22	202910	5
202288XL-SS-QC	13	202319-SS-QC	16	202326D-4-PC	22	202920	5
202295-B	11	202324-4-PC	21	202326D-6-PC	22	202930	5
202295-B-QC	11	202324-6-PC	21	202326D-B	22	202935	5
202295-SS	11	202324-B	21	202326D-B-QC	22	202950	5
202295-SS-QC	11	202324-B-QC	21	202326D-SS	22	202955	5
202295D-B	11	202324-SS	21	202326D-SS-QC	22	202RCO-B-QC	23
202295D-B-QC	11	202324-SS-QC	21	202326DRP-B-QC	24	202RCOD-B-QC	23
202295D-SS	11	202324D-4-PC	21	202326DRP-SS-QC	24	202RCOL-B-QC	23
202295D-SS-QC	11	202324D-6-PC	21	202326L-4-PC	22	202RCOXL-B-QC	23
202295M-V	14	202324D-B	21	202326L-6-PC	22	202RCO-SS-QC	23
202295L-B	11	202324D-B-QC	21	202326L-B	22	202RCOD-SS-QC	23
202295L-B-QC	11	202324D-SS	21	202326L-B-QC	22	202RCOL-SS-QC	23
202295L-SS	11	202324D-SS-QC	21	202326L-SS	22	202RCOXL-SS-QC	23
202295L-SS-QC	11	202324DRP-B-QC	24	202326L-SS-QC	22	202RH2-B-QC	23
202295XL-B	11	202324DRP-SS-QC	24	202326LRP-B-QC	24	202RH2D-B-QC	23
202295XL-B-QC	11	202324L-4-PC	21	202326LRP-SS-QC	24	202RH2L-B-QC	23
202295XL-SS	11	202324L-6-PC	21	202326RP-B-QC	24	202RH2XL-B-QC	23
202295XL-SS-QC	11	202324L-B	21	202326RP-SS-QC	24	202RH2-SS-QC	23
202296-B	11	202324L-B-QC	21	202326XL-4-PC	22	202RH2D-SS-QC	23
202296-B-QC	11	202324L-SS	21	202326XL-6-PC	22	202RH2L-SS-QC	23
202296-SS	11	202324L-SS-QC	21	202326XL-B	22	202RH2XL-SS-QC	23
202296-SS-QC	11	202324LRP-B-QC	24	202326XL-B-QC	22	202RHC-B-QC	23
202296D-B	11	202324LRP-SS-QC	24	202326XL-SS	22	202RHCD-B-QC	23
202296D-B-QC	11	202324RP-B-QC	24	202326XL-SS-QC	22	202RHCL-B-QC	23
202296D-SS	11	202324RP-SS-QC	24	202326XLRP-B-QC	24	202RHCXL-B-QC	23
202296D-SS-QC	11	202324XL-4-PC	21	202326XLRP-SS-QC	24	202RHC-SS-QC	23
202296L-B	11	202324XL-6-PC	21	202327-B	22	202RHCD-SS-QC	23
202296L-B-QC	11	202324XL-B	21	202327-B-QC	22	202RHCL-SS-QC	23
202296L-SS	11	202324XL-B-QC	21	202327-SS	22	202RHCXL-SS-QC	23
202296L-SS-QC	11	202324XL-SS	21	202327-SS-QC	22	202RO2-B-QC	23
202296M-SS	14	202324XL-SS-QC	21	202327D-B	22	202RO2-SS-QC	23
202296M-SS-QC	14	202324XLRP-B-QC	24	202327D-B-QC	22	202ROH-B-QC	23
202296XL-B	11	202324XLRP-SS-QC	24	202327D-SS	22	202ROHD-B-QC	23
202296XL-B-QC	11	202325-B	21	202327D-SS-QC	22	202ROHL-B-QC	23
202296XL-SS	11	202325-B-QC	21	202327L-B	22	202ROHXL-B-QC	23
202296XL-SS-QC	11	202325-SS	21	202327L-B-QC	22	202ROH-SS-QC	23

202ROHD-SS-QC	23	211440	31	213228	36, 102	216639	32, 104
202ROHL-SS-QC	23	2114XX	30	2132XX	35	216652	32, 99
202ROHXL-SS-QC	23	211500	31, 104	213400	35	216948	32, 106
202RP1-B-QC	23	211550	32, 100	213404	36	216949	32, 106
202RP1D-B-QC	23	211600	30	213405	36	216973	32
202RP1L-B-QC	23	211800	30	213406	36	217003	56, 74
202RP1XL-B-QC	23	211905	31, 106	213408	36	223801	57, 75
202RP1-SS-QC	23	211908	31, 106	213410	36	223821	75
202RP1D-SS-QC	23	211982-10	31, 106	213420	36	223821A	75
202RP1L-SS-QC	23	211983-10	31, 106	2134XX	35	224601	57, 75
202RP1XL-SS-QC	23	211984-10	31, 106	213800	35	224604	57, 75
202RP2-B-QC	23	211988-10	31, 106	214100	39	224608	78
202RP2D-B-QC	23	212100	33	214103	39	224609	78
202RP2L-B-QC	23	212103	33	214104	39	224611	78
202RP2XL-B-QC	23	212104	33	214105	39	224621	75
202RP2-SS-QC	23	212105	33	214108	39	224621A	75
202RP2D-SS-QC	23	212108	33	214110	39	224624	75
202RP2L-SS-QC	23	212110	33	214112	39	230630	47
202RP2XL-SS-QC	23	212112	33	2141XX	39	230640	47
205312	90	212124	33	214200	39	230650	47
205315	90	212125	33	214204	39	230660	47
205465	90	212164	33	214205	39	230665	46
207950	90	212165	33	214208	39	230670	47
207960	90	212168	33	214210	39	230675	46
211100	30	2121XX	33	2142XX	39	230685	46
211104	30, 98, 100	212200	33	214300	39	230695	46
211105	30, 98, 100	212204	34	214400	39	230697	46
211108	30, 98, 100	212205	34	214406	39	234105	46
211110	30, 98, 100	212208	34	214410	39	234106	46
211112	30, 98, 100	212210	34	214420	39	234108	46
211120	30	212222	34	214430	39	234109	46
211125	30	2122XX	33	2144XX	39	234110	46
211160	30, 98	212400	33	215100	37	234111	46
211164	30, 98	212410	34	215103	37, 98, 100	234115	46
211165	30, 98	212420	34	215104	37, 98, 100	234116	46
211168	30, 98	2124XX	33	215105	37, 98, 100	234117	46
211170	30	213100	35	215108	37, 98, 100	234118	46
211174	31, 104	213103	35, 98, 100	215110	37, 98, 100	234120	46
211175	31, 104	213104	35, 98, 100	215124	37	234121	46
211178	31, 104	213105	35, 98, 100	215125	37	234125	46
211195	32, 104	213108	35, 98, 100	215164	37, 98	234126	46
2111XX	30	213110	35, 98, 100	215165	37, 98	234215	46
211200	30	213124	35	215168	37, 98	234216	46
211204	31, 102	213125	35	2151XX	37	234625	46
211205	31, 102	213163	35, 98	215200	37	234626	46
211208	31, 102	213164	35, 98	215204	38, 102	234905	46
211210	31, 102	213165	35, 98	215205	38, 102	234906	46
211222	31, 102	213168	35, 98	215208	38, 102	237501	57, 75
2112XX	30	2131XX	35	215210	38, 102	237504	57, 75
211400	30	213200	35	2152XX	37	237508	78
211405	31	213204	36, 102	215400	37	237509	78
211406	31	213205	36, 102	2154XX	37	237511	78
211408	31	213208	36, 102	216635	32	237521	75
211410	31	213210	36, 102	216637	32, 103	237521A	75
211420	31	213222	36, 102	216638	32, 104	237524	75

# Item Number Index

239287	45	307001	86	311991	50	5A11D0	51
239297	45, 99, 103, 107	308001	68, 83	312005	72, 86	5A13C0	51
239387	45	308021	68, 84	312115	72, 84	5A13D0	51
239397	45, 107	308051	68	312515	72, 86	5A13F0	51
239488	45	308115	63, 84	312565	72, 86	5A20C0	51
239498	45, 105	308201	83	312915	86	5A20D0	51
239587	45	308231	83	313955	52	5A20F0	51
239597	45, 99	308401	68, 83	313956	52	5ABAS0	54
239688	45	308501	82	313965	52	5AHPR0	53
239698	45, 107	308515	63, 86	313990	50	5AHPS0	52
239778	45	308565	63, 86	313991	50	5ASTA0	54
239779	45, 101, 107	308715	63, 86	313992	50	520110	74, 85
239787	45	308915	86	318005	86	520210	74, 85
239798	45, 101	308955	52	320001	76, 82	520310	74, 85
239888	45, 99, 103, 107	308990	50	320005	86	520410	74, 85
246124	44, 101	309041	67	320101	76, 86	520510	74, 85
246225	44, 99, 103, 107	309042	67	320121	77, 83	520810	74, 85
246228	44, 99, 103, 107	309042R	67	320122	77, 83	521110	74, 85
246325	44, 107	309044	67	320123	77, 83	614158	95
246424	44, 105	309045	67	320124	78, 85	614160	95
246525	44, 99	309115	63, 84	320125	78, 85	614161	95
246624	44, 107	309415	63	320126	78, 85	614163	95
246713	44, 101, 107	309525	63, 84	320128	78, 85	614170	95
246725	44, 101	309585	63, 84	320129	78, 85	614250	95
271425	57, 81	309715	63, 86	320130	77	644350	95
271435	81	309925	74, 85	320201	76, 86	644850	95
275705	57, 74, 79	309935	74, 85	320221	77, 83	868850	87
275725	79	310001	86	320222	77, 83	868880	87
275745	80	310005	65, 86	320223	77, 83	868880AS	87
275805	79	310115	65, 84	320301	76, 82	868880B	87
275825	81	310515	65, 86	320401	76, 86	868880G	87
275835	81	310615	65, 86	320421	77, 83	868880O	87
275905	79	310815	65, 86	320501	76, 86	868880P	87
279505	74, 79	311001	59, 83	320521	77, 83	868880R	87
279515	57, 74, 79	311001B	59, 83	320545	76, 86	868880Y	87
279525	79	311001G	59, 83	320605	76, 82	HPB6-A	54
279535	79	311001GO	59, 83	320607	76, 82		
279545	80	311001O	59, 83	320610	77, 83		
279580	81	311001PU	59, 83	320955	52		
279815	81	311001R	59, 83	320956	52		
279816	81	311001Y	59, 83	320965	52		
279825	81	311002	59, 82	320990	50		
279835	81	311021	84	320991	50		
298705	43, 101	311201	59, 83	320992	50		
298713	43, 101, 107	311231	59, 83	322005	79, 86		
298717	43, 99, 103, 107	311251	61	322515	79, 86		
298718	43, 99, 103, 107	311261	61	322516	79, 86		
298727	43, 107	311271	61	322545	70, 79		
298735	43, 105	311281	61	322550	79, 86		
298745	43	311401	59, 83	324114	79, 84		
298755	43	311501	82	324115	79, 84		
298777	43, 101	311715	72, 86	324415	79, 80, 84		
298787	43, 99	311955	52	324425	79, 80, 81, 84		
298817	43, 107	311965	52	5A08C0	51		
306001	57, 75	311990	50	5A11C0	51		



# Product Index

- A**  
AFS Purifiers  
AFS Purifier I ..... 4-5  
AFS Purifier II ..... 4-5  
AFS Purifier III ..... 4-5  
Agilent Instruments  
Ferrules - Graphite ..... 98  
Ferrules - Vespel/Graphite ..... 98  
Liner Seals; O-ring ..... 99  
Premium Septa ..... 99
- B**  
Bruker Instruments  
Ferrules - Graphite ..... 100  
Ferrules - Vespel/Graphite ..... 100  
Premium Septa ..... 101
- C**  
Carbon Dioxide Purifier ..... 26  
Column Scribe ..... 90  
Crimper  
Accessories ..... 54  
Electronic ..... 51  
High Power Jaw Set ..... 52-53  
Manual ..... 50
- D**  
Decapper  
Accessories ..... 54  
Electronic ..... 51  
High Power Jaw Set ..... 52-53  
Manual ..... 50  
Disposable Syringes ..... 96
- E**  
Economy Blue Septa ..... 46  
Electronic Crimping Tool ..... 51  
Electronic Decapping Tool ..... 51  
Electronic Replacement  
Battery ..... 54  
EPA Sampling Vials  
Bulk EPA Vials ..... 79  
Preassembled Vials ..... 80  
Prcleaned Vials ..... 81  
PreAssembled Screw Caps ..... 84  
Prestuffed Crimp Caps ..... 83  
Caps, 24 mm ..... 79  
Seals, 22 mm ..... 79
- F**  
Ferrules  
Graphite ..... 30-32  
PTFE ..... 39  
Vespel ..... 33-34  
Vespel/Graphite SP-21 ..... 37-38  
Vespel/Graphite SP-22 ..... 35-36  
Ferrule Remover ..... 90
- G**  
Gas Purifiers  
AFS Purifier I ..... 4-5  
AFS Purifier II ..... 4-5  
AFS Purifier III ..... 4-5  
Carbon Dioxide ..... 10, 14, 26  
Hydrocarbon ..... 8, 14, 26  
M Filter ..... 14  
Moisture ..... 9, 14, 17-18, 20  
Oxygen ..... 7, 17, 25  
PolyGas I ..... 12, 16  
PolyGas II ..... 13, 16  
SPure ..... 19-22  
ZPure ..... 7-18  
Graphite Ferrules ..... 30
- H**  
Headspace Vials  
Crimp Top ..... 75-77  
Screw Top ..... 78  
High Power Crimping Tool ..... 52-53  
HPLC Vials ..... 68  
Hydrocarbon Purifier ..... 8, 14, 26
- I**  
Ion Exchange SPE Cartridges ..... 94
- L**  
Legacy Purifiers  
Carbon Dioxide ..... 26  
Model 300, Hydrocarbon ..... 26  
Model 500, Moisture ..... 25  
Model 1000, Oxygen ..... 25  
Liner Seals ..... 32
- M**  
Manual Hand Crimper ..... 50  
Manual Hand Decapper ..... 50
- N**  
Mininert Valves ..... 95  
Moisture Filters ..... 9, 14, 17-18, 20
- N**  
Non-Silica SPE Cartridges ..... 93  
Normal Phase  
SPE Cartridges ..... 94
- O**  
Oxygen Filter ..... 7, 17, 25
- P**  
PerkinElmer Instruments  
Ferrules - Graphite ..... 102  
Ferrules - Vespel/Graphite ..... 102  
O-Ring ..... 103  
Premium Septa ..... 103  
PTFE Ferrules ..... 39  
PTFE Lined Screw Caps ..... 74, 85  
Puresep Septa ..... 46-47  
Purifiers, Gas  
AFS Purifier I ..... 4-5  
AFS Purifier II ..... 4-5  
AFS Purifier III ..... 4-5  
Carbon Dioxide ..... 10, 14, 26  
Hydrocarbon ..... 8, 14, 26  
M Filter ..... 14  
Moisture ..... 9, 14, 17-18, 20  
Oxygen ..... 7, 17, 25  
PolyGas I ..... 12, 16  
PolyGas II ..... 13, 16  
SPure ..... 19-22  
ZPure ..... 7-18
- R**  
Reaction Vials ..... 70, 95  
Reverse Phase  
SPE Cartridges ..... 92
- S**  
SPure Filters  
Hydrocarbon ..... 22  
Moisture ..... 20  
Moisture/Hydrocarbon ..... 21  
Quick Connect Kit Cartridge  
Replacements ..... 24  
Sample Preparation  
Disposable Syringes ..... 96
- S**  
Mininert Valves ..... 95  
Reaction Vials ..... 95  
Solid Phase Extraction ..... 91-94  
Syringe Filters ..... 96  
Sample Vials ..... 74  
Septa, GC  
Advanced Green 3 ..... 44  
BTO ..... 43  
Economy Blue ..... 46  
Marathon ..... 45  
Puresep P ..... 47  
Puresep T ..... 46  
Septa, GC Accessories  
Septa Pick ..... 90  
Shimadzu Instruments  
Ferrules - Graphite ..... 104  
Liner Seals; O-ring ..... 104  
Premium Septa ..... 105  
Solid Phase Extraction  
Ion Exchange ..... 94  
Non-Silica ..... 93  
Normal Phase ..... 94  
Reverse Phase ..... 92  
Storage Racks  
Autosampler Vial ..... 87  
Syringe Filters ..... 96
- T**  
Thermo Instruments  
Ferrules - Graphite ..... 106  
Graphite Liner Seal ..... 106  
Premium Septa ..... 107
- U**  
Universal Fused Silica  
Connectors  
Universal Quartz Connector ..... 90  
Universal Y-Splitter ..... 90
- V**  
Vespel Ferrules - SP-1 ..... 33  
Vespel/Graphite Ferrules  
85/15 SP-21 ..... 37-38  
60/40 SP-22 ..... 35-36  
Vials  
12 x 32 mm Crimp ..... 58-61  
12 x 32 mm Inserts ..... 66  
12 x 32 mm Screw ..... 62-65  
15 x 45 mm Vials ..... 71-73



# Product Index

9 mm, 1.8 mL Screw . . . . .	67	PolyGas I . . . . .	12
Conical Vials . . . . .	64	PolyGas II. . . . .	13
EPA Vials . . . . .	79-81	Quick Connect Kit Cartridge Replacements . . . . .	23
Headspace, Crimp . . . . .	75-77	ZPure Purifiers - Glass Body	
Headspace, Screw . . . . .	78	Moisture . . . . .	17-18
HPLC Vials . . . . .	68	Oxygen . . . . .	17
Inserts . . . . .	58, 60, 62, 66, 71	PolyGas I . . . . .	16
Standard Mouth . . . . .	58, 62, 66	PolyGas II. . . . .	16
Wide Mouth . . . . .	60, 66	Quick Connect Kit Cartridge Replacements . . . . .	24
Reaction Vials . . . . .	70, 95		
Sample Vials . . . . .	74		
Shell Vials. . . . .	69		

## Vials, Caps and Seals

7.5 mm Seal . . . . .	86
8 mm Crimp . . . . .	68, 82, 83
8 mm Screw . . . . .	63, 84
8 mm Seal . . . . .	63, 86
9 mm Prestuffed Screw. . . . .	67
9 mm Seal . . . . .	65, 86
10 mm Screw . . . . .	65, 84
10 mm Seal . . . . .	86
11 mm Crimp . . . . .	82, 83
12 mm Screw . . . . .	72, 84
12 mm Seal . . . . .	72, 86
18 mm Seal . . . . .	86
20 mm Crimp Caps . . . . .	76, 82, 83
20 mm PreStuffed Caps, Seals . . . . .	77, 83
20 mm Seals . . . . .	76, 86
22 mm Seals . . . . .	70, 79, 86
24 mm Screw Caps . . . . .	80, 84
EPA Screw Caps, Prestuffed . . . . .	80
Headspace Crimp Cap, 20 mm . . . . .	76-77
Headspace Screw Caps, 20 mm . . . . .	78
Magnetic Screw Caps . . . . .	78, 85
Polyethylene Plug Caps . . . . .	84
PTFE Lined Screw . . . . .	74, 85
Snap Cap . . . . .	61
Soil Sample Septa . . . . .	70, 79, 86

## Z

ZPure M Filters. . . . .	14
ZPure Purifiers - SS Body	
Carbon Dioxide. . . . .	10
Hydrocarbon. . . . .	8
M Filter . . . . .	14
Moisture . . . . .	9
Oxygen. . . . .	7
Oxygen/Moisture . . . . .	11

# Trademarks

These trademarks are the property of Chromatography Research Supplies, Inc.:

Advanced Green 3  
CoFree  
Marathon  
Puresep P  
Puresep T  
Septa BTO  
SPure  
Ultra Precise  
TruSeal  
ZPure

These trademarks are the property of the companies listed below:

CP SIL - Chrompack  
CP-Wax - Chrompack  
Duran - Schott Glaswerke, Germany  
Florisil - U.S. Silica Co.  
Imp - Gould, Inc. Valve and Fitting Division  
Kel-F - 3M Company  
Mininert - Dynatech Precision Sampling Corp.  
Pyrex - Corning Glass Works  
Univial - Chromacol, Inc.  
Vespel - E. I. duPont de Nemours & Co., Inc.  
WISP - Waters Associates

All other trademarks herein are the property of their respective owners.

## Services That Revolves Around You!

### General Warranty Information

CRS provides a 1 year warranty on all Electronic Crimping Tools.

### Returns/Refunds/Exchanges

We stand behind every product we sell! We are proud of our customer-first reputation and provide a no-hassle return policy. If any of our products fail to meet your expectations, simply contact [Sales@ChromRes.com](mailto:Sales@ChromRes.com) for a return material authorization (RMA) form to return it for a full refund or exchange.

### Commitment to Quality

CRS is obligated to supply its customers with products that meet agreed requirements for quality, price, quantity, delivery and schedule.

### Genuine Value

Quality products, technical support and guaranteed performance define value at CRS. Value is enhanced by competitive pricing, and measured by the growing satisfaction of customers, who trust CRS to supply their analytical needs.

### Technical Support

At CRS, we understand your applications, and can help you get the best results from our products. You can feel confident knowing the products offered are selected for performance and quality.

### Quick Delivery

CRS stocks thousands of our most popular items for immediate shipment. We can also supply the hard-to-find items you need. Most orders are shipped within 24 hours of receipt, and rush service is available.

# Ordering Information

## Phone

You can call in your order at one of the following phone numbers:

(800) 327-3800 (US only)

(502) 491-6300

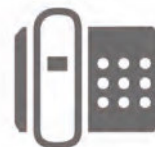

## Fax

Place your order by fax at

(502) 491-3390



## Email

Email us your order at  
Sales@ChromRes.com



## Online Order

You can visit us at [www.ChromRes.com](http://www.ChromRes.com)



## Chat

You can chat with us in real time and get help ordering online



## Quotes

If you would like to get a pricing quote please contact us by phone, email, or fax, and we will be happy to assist you.

## For Customer Service or Technical Support

We understand your applications, and can help you get the best results from our products. Please contact us by phone or email with any technical support questions or general product information and we would be happy to assist you.

## Worldwide Distribution

A substantial part of CRS sales are exported, and the company ships to markets all around the world. Our products are used in analytical laboratories worldwide in various industries including food safety, flavor, fragrance, environmental, pharmaceutical, petrochemical, and forensic sciences.



Visit <https://www.ChromRes.com/distributors> to find a local CRS Distributor.

If you cannot find a local representative, please contact CRS.

Chromatography Research Supplies, Inc.

+ 1.502.491.6300 International

1.800.327.3800 U.S. Only

Sales@ChromRes.com

